



GRANDCASA

» INSPIRATION 2023

ABRIS DE JARDIN • POOLHOUSES • BUREAUX DE JARDIN

DU SUR-MESURE
AUX PRIX STANDARDS

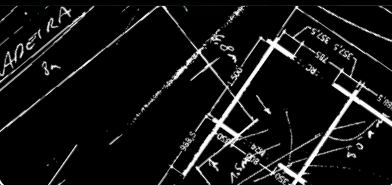

PEFC™
PEFC/07-31-200

Promouvoir
la gestion
durable
de la forêt
www.pefc.org

CONTENU



Durabilité	6 - 7
Classic	8 - 21
Cosmos	22 - 23
Mimas	34 - 41
Cottage & Country	42 - 57
Granges	58 - 63
Fenêtres & portes	64 - 67
Royal	68 - 77
PEFC	78 - 79
Chalets forestiers	80 - 87
Industry	88 - 96
Couverture du toit	97
Abris de salon	98 - 105
Takai-Hikui	106 - 111
Wellness sauna	112 - 117
She Shed	118 - 123
Style rural	124 - 129
Couleur et entretien	130 - 131
Elegance	132 - 145
Bureaux de jardin	146 - 151
Intérieur	152 - 153
Chalets de loisirs	154 - 163
Isolation	164
Garages	166 - 175
Tonnelles	176 - 183
Options	184

LÉGENDE



Épaisseur



Hauteur de faîte



Hauteur à côté



Débords de toit



Couvertures de toit



Pente du toit

TYPES DE TOITURE



Classic
toit en bâtière 19°



Toiture simple pente



Cottage
toit en bâtière 42°



Royal
toit pyramidal



Country
toit en croupe



Colorado
toit mansardé



Cosmos
toit plat



Toit asymétrique



PEFCTM

PEFC/07-31-200

POUR LA GESTION DURABLE DES FORÊTS



UN TRAVAIL SUR MESURE EN 3 ÉTAPES

1

VOTRE IDÉE

Tout commence avec votre idée de la construction de vos rêves. Notre catalogue peut vous aider à trouver l'inspiration. Vous pouvez faire quelques dessins et/ou croquis.



2

CONTACTEZ LE POINT DE VENTE LE PLUS PROCHE

Prenez contact avec le point de vente de votre région. Vous pouvez nous rendre visite pendant les heures d'ouverture ou prendre rendez-vous avec un de nos conseillers.



3

VOTRE DEVIS PERSONNALISÉ

Notre expert traduira vos souhaits de façon technique et évaluera la faisabilité de votre projet. Sur la base de cet entretien, il vous remettra un devis personnalisé du projet de vos rêves.



DU SUR-MESURE À DES PRIX STANDARDS

- ✓ UN CERTIFICAT D'AUTHENTICITÉ
- ✓ AUCUN PRODUIT VIENT D'EUROPE DE L'EST, C'EST GARANTI
- ✓ UNE GARANTIE DE 10 ANS SUR LES DÉFAUTS DE PRODUCTION ET/OU DE FABRICATION



PRODUITS DE CHEZ NOUS

CERTIFICAT D'AUTHENTICITÉ = CERTIFICAT D'ORIGINE

Un certificat d'authenticité est en réalité un certificat d'origine. De cette manière, nous vous garantissons que votre chalet Grandcasa est un produit d'origine qui provient de nos manufactures et a été produit dans les pays du Benelux selon le principe des profilés de chalet coupe-vent, notre label de qualité Force Plus.

Ce label de qualité garantit également l'origine et la qualité du bois. Les chalets de la marque Grandcasa sont aussi certifiés PEFC.

Le certificat d'origine de nos chalets vous garantit que votre chalet a été produit en suivant un processus de production de qualité conforme aux normes occidentales avec du bois de qualité, cultivé dans le respect de l'environnement. Nous avons développé ce certificat d'authenticité parce qu'il existe sur le marché des produits bien meilleur marché, mais de qualité moindre, fabriqués en Europe centrale et/ou de l'Est selon un processus de fabrication douteuse et avec du bois de moins bonne qualité. Souvent, la vraie qualité du produit est passée sous silence, mais le client apprend tôt ou tard les conséquences désastreuses de son choix. Nous vous conseillons donc d'acheter un chalet avec un certificat d'origine. Au final, vous ferez des économies. Méfiez-vous des copies bon marché provenant d'Europe de l'Est.

DEMANDEZ TOUJOURS VOTRE CERTIFICAT D'AUTHENTICITÉ!

Faites attention aux
constructions
inférieures
de l'Europe de l'Est



SERVICE ET GARANTIE

Notre service après-vente est disponible 6 jours sur 7, du matin au soir. Nos services production et service après-vente se situent en Belgique, à proximité de nos clients ! C'est pourquoi nous vous offrons une garantie de 10 ans sur les défauts de production et/ou de fabrication.

CERTIFICAT D'AUTHENTICITE



voir catalogue



LE SPÉCIALISTE DU SUR MESURE

Par ce certificat on déclare que la construction Grandcasa, objet du bon de commande _____, est une production authentique de Top-Cottage, originaire du site de production à Elversele, Belgique, et également produit selon la norme de qualité Force Plus pour les profils en coupe-vent.

Ce certificat garantit également que la construction mentionnée ci-dessus est construite avec du bois qualitatif-pin, originaire du Nord de l'Europe, livrée conforme à la norme NEN(5466) avec le certificat KOMO correspondant et certifiée PEFC (CoC N° CTIB-TCHN 0938).

Elversele - Belgique, 2023

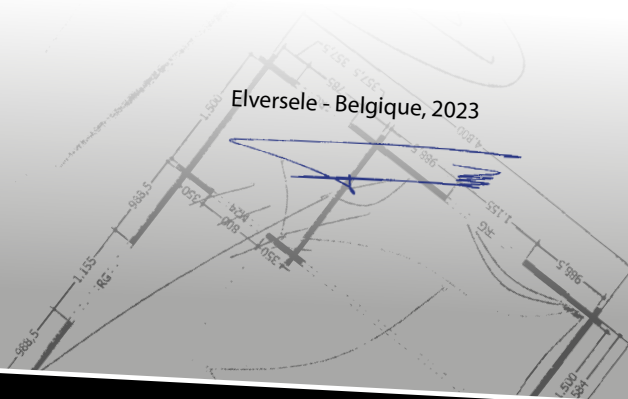

Emis par:
Pontweg 9C - 9140 Elversele - tél: +32 (0)52 460 111
info@top-cottage.com

www.top-cottage.com



PROFIL IMPERMÉABLE AU VENT

- Double fraisage
- Les plus grandes rainures et languettes du marché. 15 mm assure une plus grande robustesse



DU BOIS DE QUALITÉ

Les chalets Grandcasa sont fabriqués avec du pin de qualité provenant d'Europe du Nord, selon les normes NEN 5466, et ils sont livrés avec un certificat KOMO. Le froid fait pousser ces arbres plus lentement, ce qui rend le bois plus solide et permet de garantir une durée de vie sensiblement plus longue à nos chalets.

LA BOUCLE DE DURABILITÉ



À travers sa marque **Grandcasa, Chalet Center** souhaite explicitement contribuer au développement durable. Notre concept se fonde sur la définition formulée par les Nations Unies en 1987 :

" Le développement durable est un développement qui répond aux besoins du présent sans compromettre la capacité des générations futures de répondre à leurs propres besoins. "

Par conséquent, nous mettrons tout en œuvre pour contribuer à la préservation de notre planète grâce à la production aussi respectueuse que possible de l'environnement et aux applications qui respectent une vision écologique de la vie et peuvent être fondamentalement considérées comme durables.

Voilà pourquoi notre 'Chalet Center boucle de durabilité' se fonde sur 3 facettes.



1

Les panneaux solaires installés sur le toit de nos usines couvrent 45 % des besoins en électricité pour notre production. La production annuelle attendue est supérieure à 211 000 kWh, fournie par 576 modules à haut rendement en cristallin. De plus, notre bois traité est entièrement certifié PEFC (voir plus loin).



2

Nos constructions de jardin en bois sont dotées de structures de toit très solides qui peuvent parfaitement servir de base à l'aménagement d'un toit vert **extensif** (épaisseur \geq 45 mm obligatoire)



3

Nos structures de toit, y compris nos toits plats, sont suffisamment solides et conviennent même parfaitement à l'installation de panneaux. Nos constructions de jardin jouent ainsi un rôle important dans la production privée d'énergie renouvelable.

CLASSIC





CLASSIC

Notre gamme Classic propose des abris de jardin de caractère et d'excellente qualité avec en plus un look distinctif et authentique.

Nos modèles Classic taillés sur mesure vous donneront aussi une série des idées bien pensées pour réaliser vos rêves en matière d'abris de jardin.

AVANTAGES

- Pente de toit de 19°
- Portes surélevées (196 cm)
- Vaste assortiment de fenêtres et portes avec toujours du verre authentique
- Le plus grand choix de toitures : shingles, panneaux profilés métalliques, panneaux de tuiles
- Possibilité abri annexe



CLASSIC BASIC



Façade:	1 - 10 m
Profondeur:	1 - 30 m
Hauteur:	2,77 - 3,80 m
Fenêtres:	
Portes:	

CLASSIC BASIC

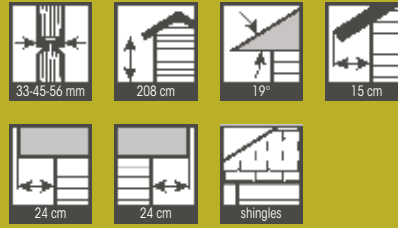

Avec bûcher



Avec auvent



Configurations possibles



CLASSIC

JUDA

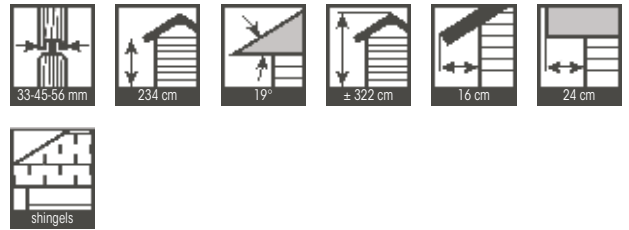
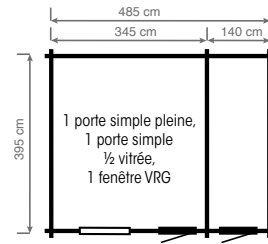

PADRO

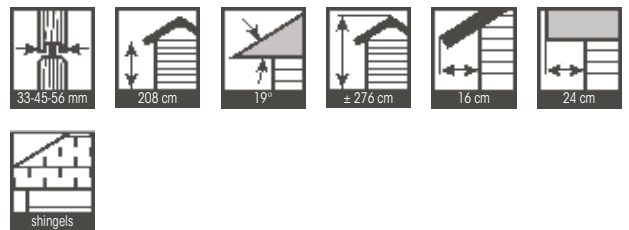
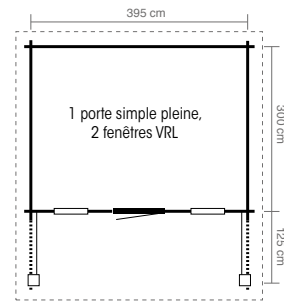



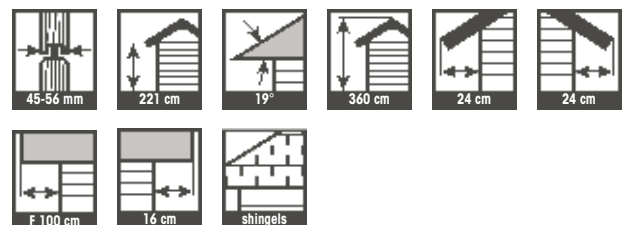
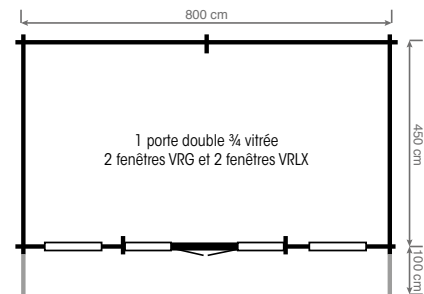

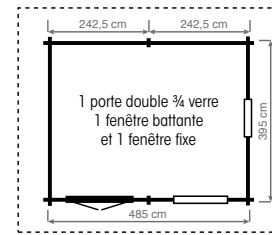

CHALKI



ATHOS







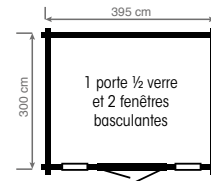



-  33-45-56 mm
-  221 cm
-  287 cm
-  9°
-  77 cm
-  Panneau profilés métallique

COLORADO







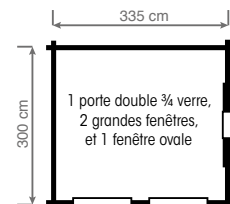

Disponible en différentes dimensions

-  33-45-56 mm
 -  208 cm
 -  42° + 24°
 -  335 cm
 -  16 cm
 -  24 cm
-  24 cm
 -  shingles

PETRUS



-  33-45-56 mm
-  241 cm
-  42°
-  381 cm
-  24 cm
-  shingles

CLASSIC

BARBADOS

panneaux de tuiles en option

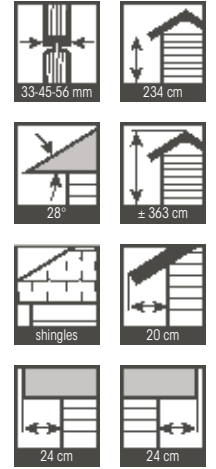
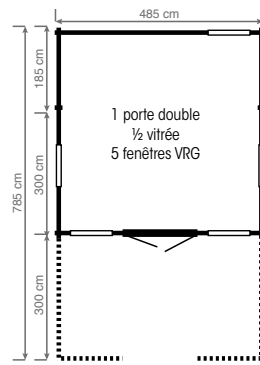

BELIZE

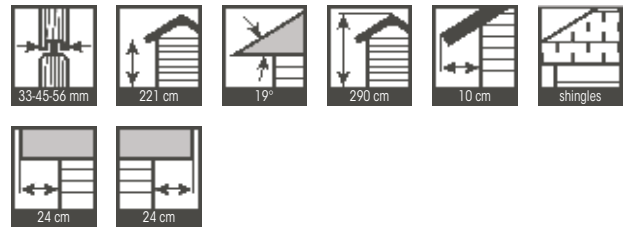
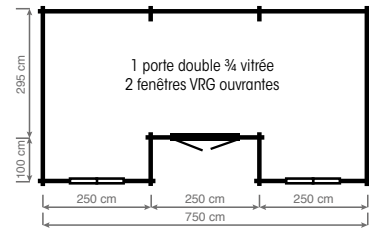

CARTAGENA

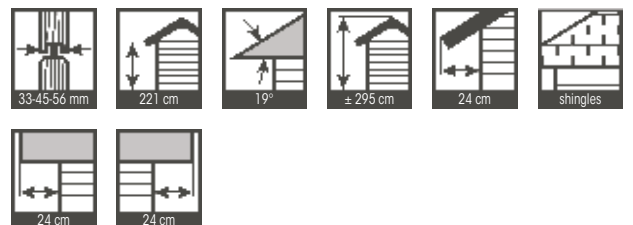
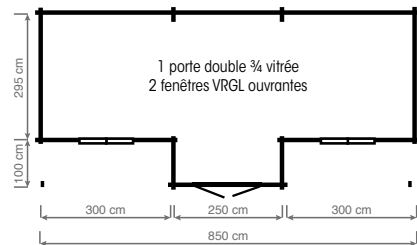

KRETA



set de gouttières en option

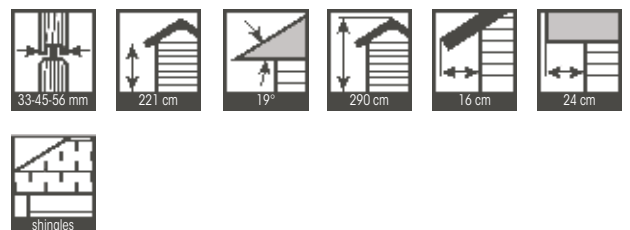
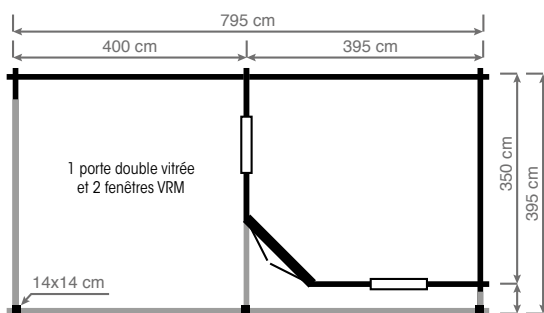

CLASSIC

MAKIRA

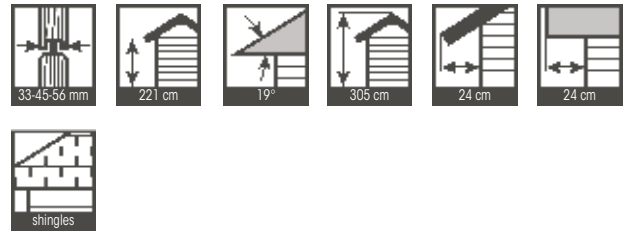
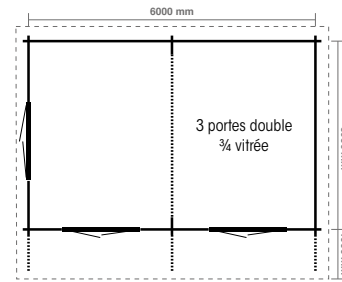

BONAIRE

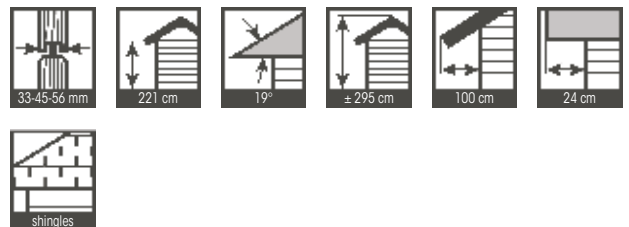
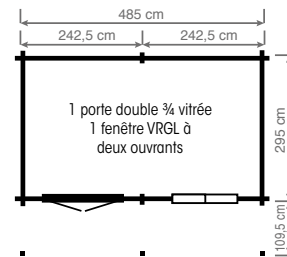

ROATAN

set de gouttières et panneaux tuiles en option

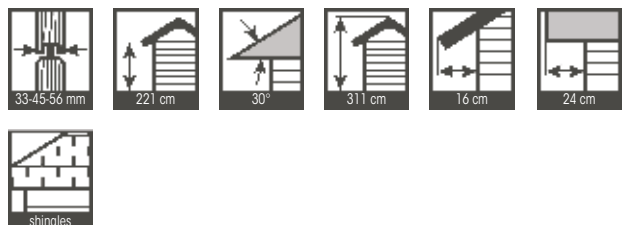
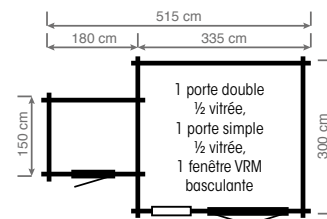

EVORA

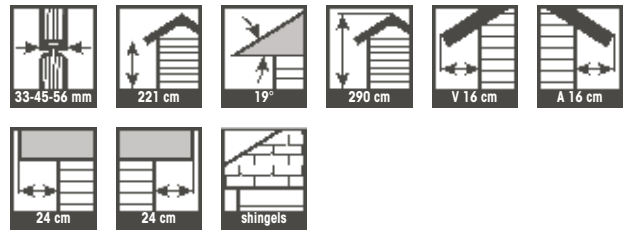
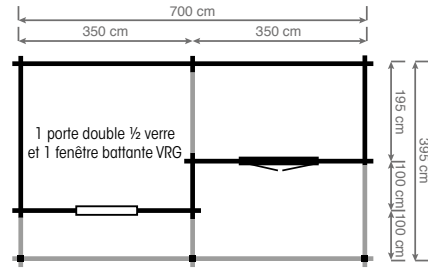

KAMANA

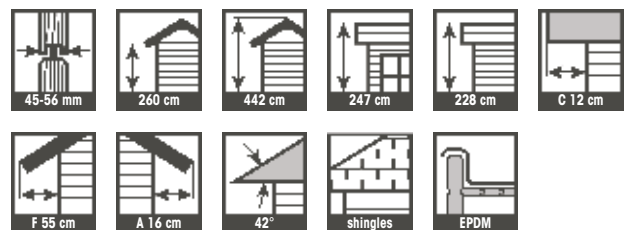
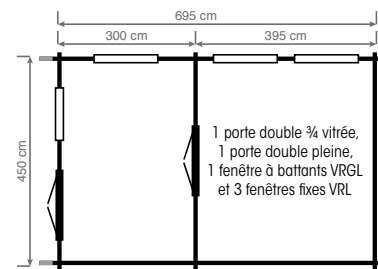

KOMLO

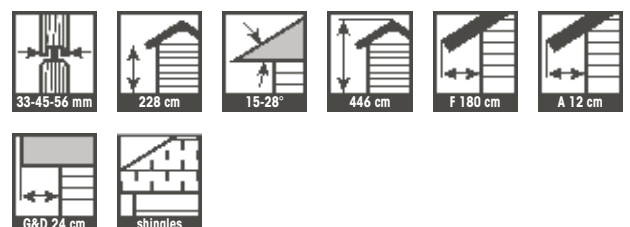
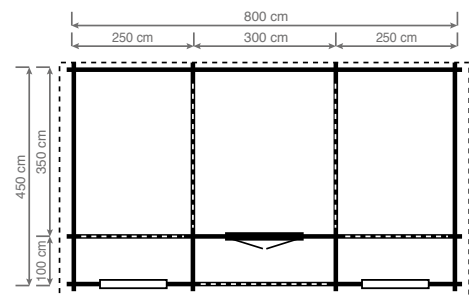

CLASSIC

RODOS

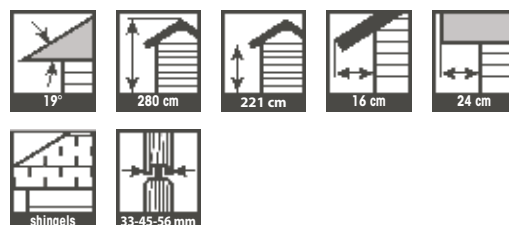
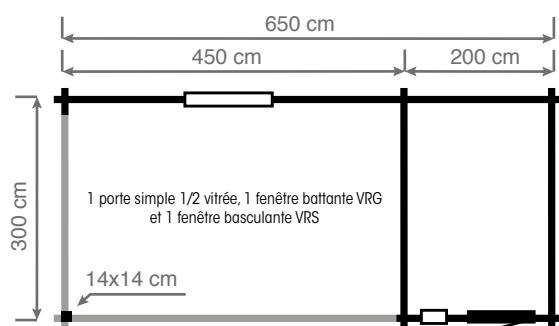

KALYMOS

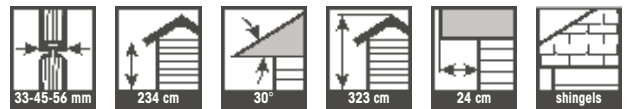
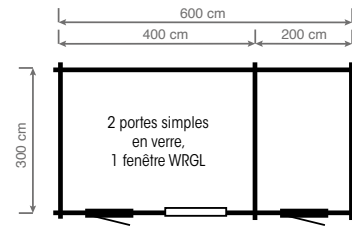

TINOS

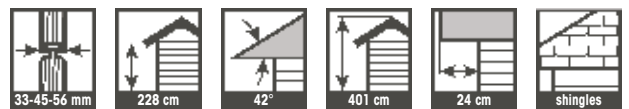
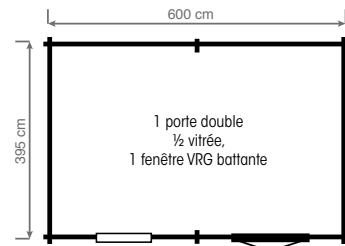

SAMOS

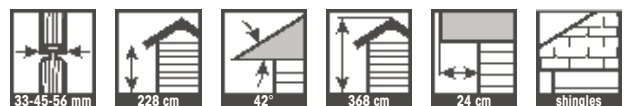
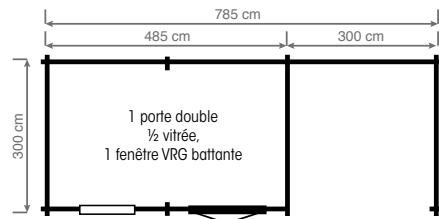

CLASSIC



BARANQUILA

set de gouttières en option

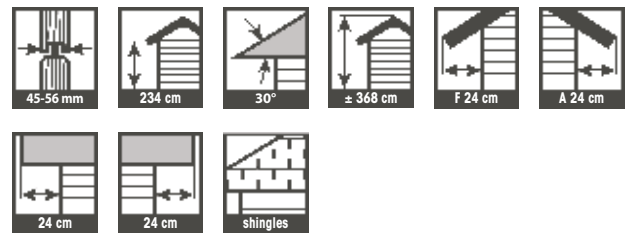
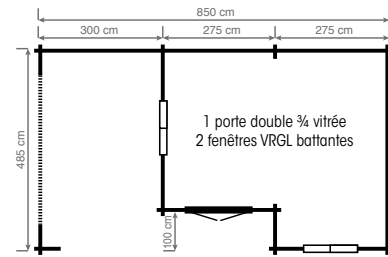

ANDROS

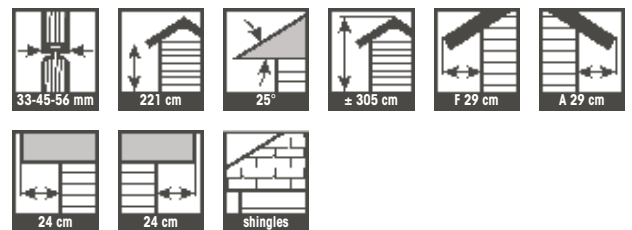
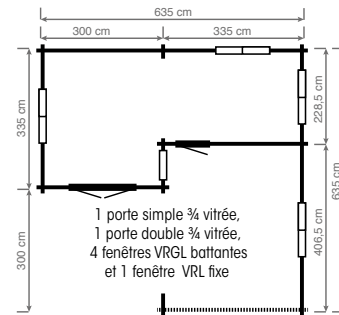

PAROS

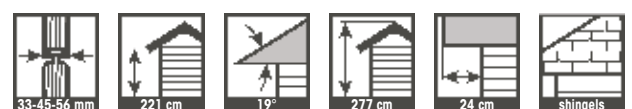
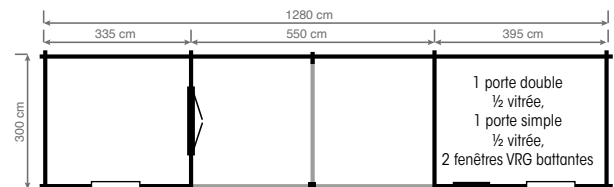



PRODUITS DE CHEZ NOUS



CERTIFICAT D'AUTHENTICITE



PEFC
PEFC/07-31-200

PRODUIT DE CHEZ NOUS



LE SPÉCIALISTE DU SUR MESURE

Par ce certificat on déclare que la construction Grandcasa, objet du bon de commande _____, est une production authentique de Top-Cottage, originaire du site de production à Elversele, Belgique, et également produit selon la norme de qualité Force Plus pour les profils en coupe-vent.

Ce certificat garantit également que la construction mentionnée ci-dessus est construite avec du bois qualitatif-pin, originaire du Nord de l'Europe, livrée conforme à la norme NEN(5466) avec le certificat KOMO correspondant et certifiée PEFC (CoC N° CTIB-TCHN 0938).

Elversele - Belgique, 2023



Emis par:
Pontweg 9C - 9140 Elversele - tél: +32 (0)52 460 111
info@top-cottage.com

www.top-cottage.com

CERTIFICAT D'AUTHENTICITÉ = CERTIFICAT D'ORIGINE

Un certificat d'authenticité est en réalité un certificat d'origine. De cette manière, nous vous garantissons que votre chalet Grandcasa est un produit d'origine qui provient de nos manufactures et a été produit dans les pays du Benelux selon le principe des profilés de chalet coupe-vent, notre label de qualité Force Plus.

Ce label de qualité garantit également l'origine et la qualité du bois. Les chalets de la marque Grandcasa sont aussi certifiés PEFC.

Le certificat d'origine de nos chalets vous garantit que votre chalet a été produit en suivant un processus de production de qualité conforme aux normes occidentales avec du bois de qualité, cultivé dans le respect de l'environnement. Nous avons développé ce certificat d'authenticité parce qu'il existe sur le marché des produits bien meilleur marché, mais de qualité moindre, fabriqués en Europe centrale et/ou de l'Est selon un processus de fabrication douteuse et avec du bois de moins bonne qualité. Souvent, la vraie qualité du produit est passée sous silence, mais le client apprend tôt ou tard les conséquences désastreuses de son choix. Nous vous conseillons donc d'acheter un chalet avec un certificat d'origine. Au final, vous ferez des économies. Méfiez-vous des copies bon marché provenant d'Europe de l'Est.

DEMANDEZ TOUJOURS VOTRE CERTIFICAT D'AUTHENTICITÉ!

Faites attention aux constructions inférieures de l'Europe de l'Est

SERVICE ET GARANTIE

Notre service après-vente est disponible 6 jours sur 7, du matin au soir. Nos services production et service après-vente se situent en Belgique, à proximité de nos clients ! C'est pourquoi nous vous offrons une garantie de 10 ans sur les défauts de production et/ou de fabrication.



PROFIL IMPERMÉABLE AU VENT

- Double fraisage
- Les plus grandes rainures et languettes du marché. 15 mm assure une plus grande robustesse



DU BOIS DE QUALITÉ

Les chalets Grandcasa sont fabriqués avec du pin de qualité provenant d'Europe du Nord, selon les normes NEN 5466, et ils sont livrés avec un certificat KOMO. Le froid fait pousser ces arbres plus lentement, ce qui rend le bois plus solide et permet de garantir une durée de vie sensiblement plus longue à nos chalets.



COSMOS





COSMOS

Cette gamme est synonyme de design moderne, sobre et contemporain. Le toit plat est équipé d'un système d'écoulement. L'eau est ainsi évacuée par l'arrière avec un ensemble de gouttières compris dans l'offre standard. Ces constructions sont assorties de portes pleines standard ou des portes en verre dépoli.

EPDM AVEC AVALOIR POUR ÉGOUTTAGE



AVANTAGES

- Sous-toiture : planches massives de 19 mm, dent/rainure
- Gouttière avec système d'écoulement compris
- Toiture : caoutchouc EPDM, 400% élastique, finition avec un profilé en aluminium élégant de 35 x 45 mm avec angles prémontés
- Plaques métalliques galvanisées en option
- Gamme de portes et fenêtres contemporaines, pleines ou en verre authentique, brillantes ou mates



COSMOS BASIC



Façade:	1 - 30 m
Profondeur:	1 - 10 m
Hauteur:	2,47 m
Fenêtres:	
Portes:	

COSMOS BASIC

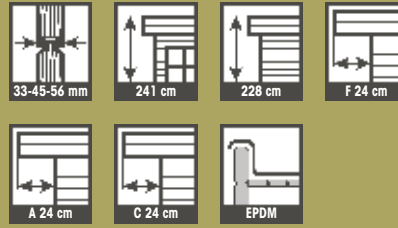

Avec bûcher



Avec auvent



Configurations possibles

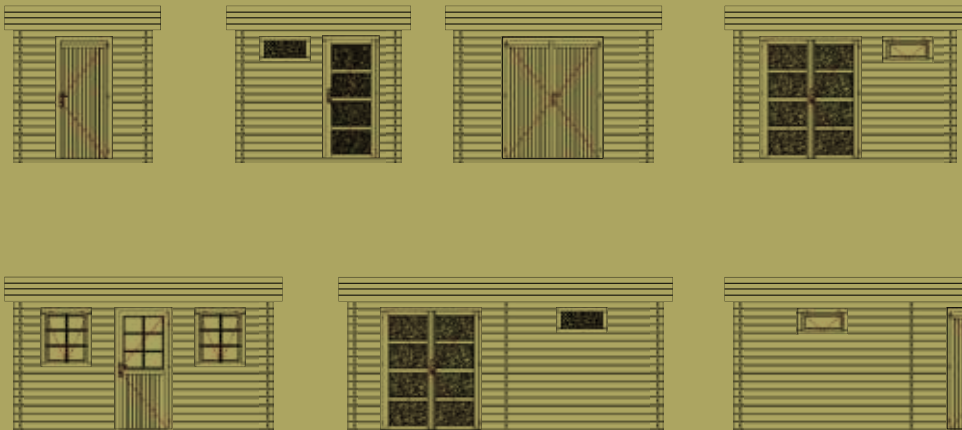

COSMOS

LESBOS

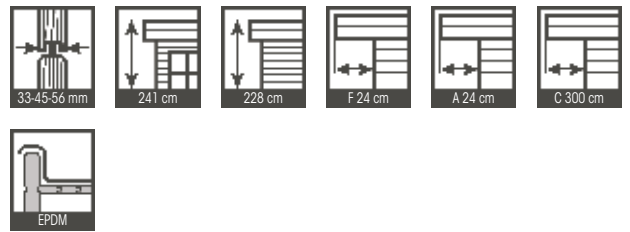
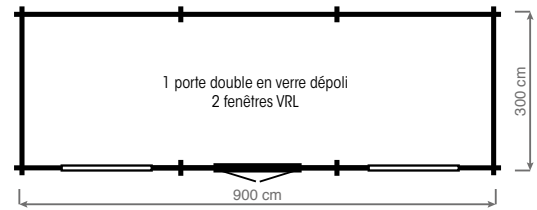

PINTA

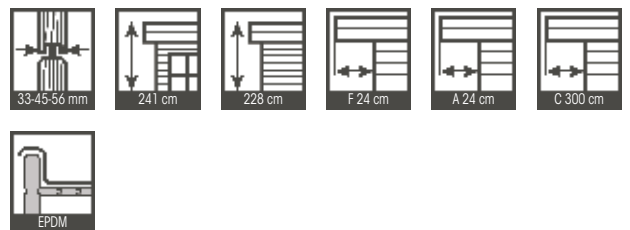
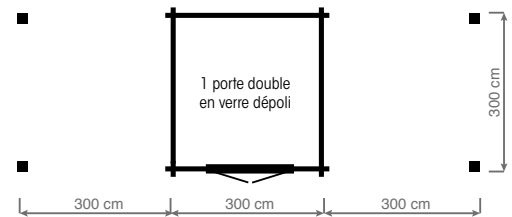

NASSAU

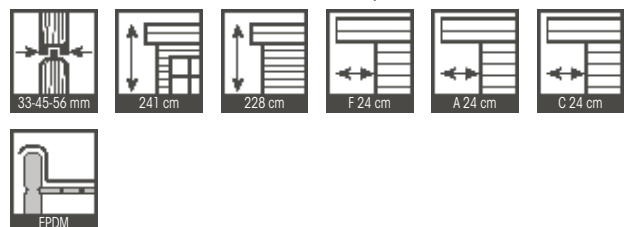
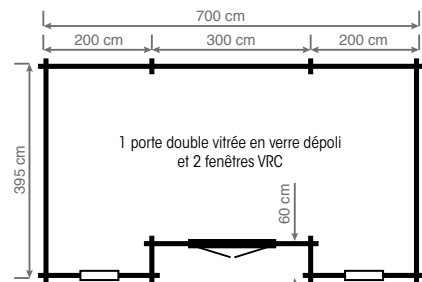

MARTINA

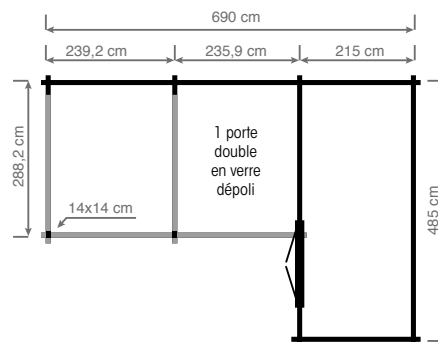

AGNETA

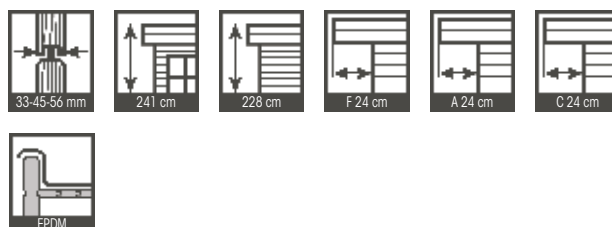
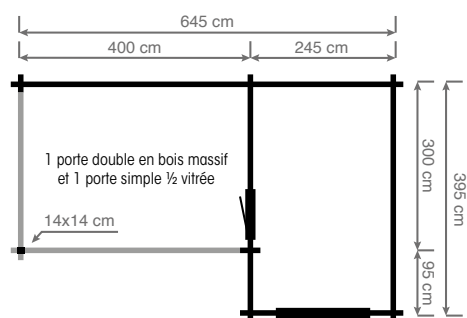

DIONE

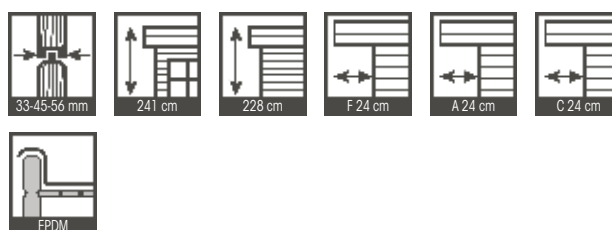
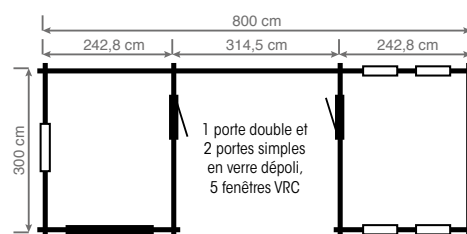

COSMOS

HAFA

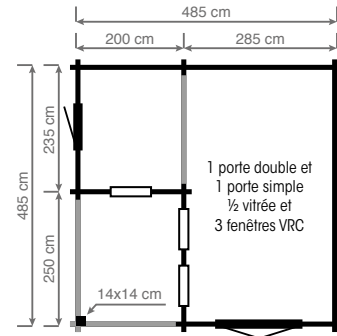

GUYANA

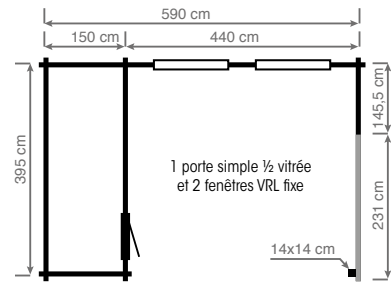

TATIANA

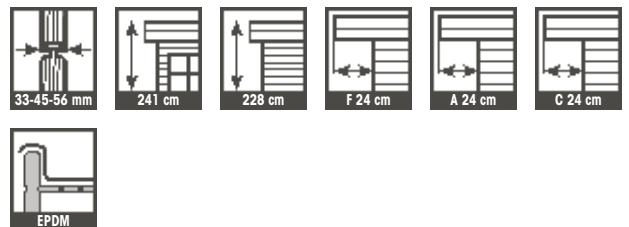
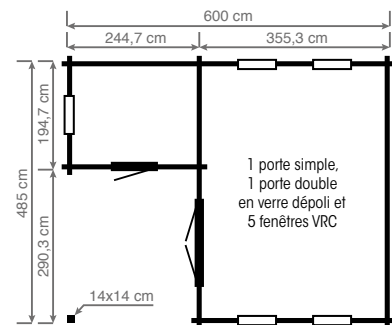

CÉZANNE

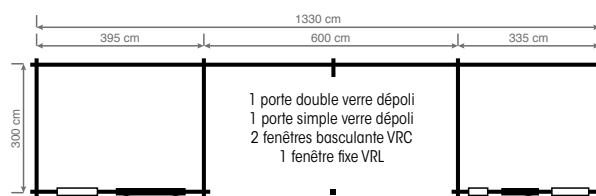

FABRE

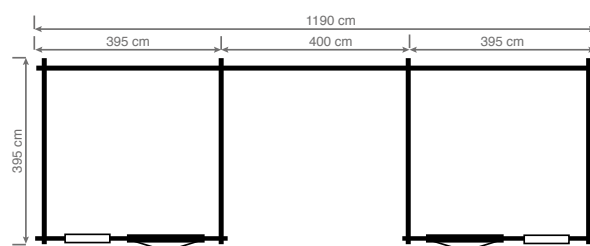

2 portes doubles verre dépoli, 2 fenêtres basculantes

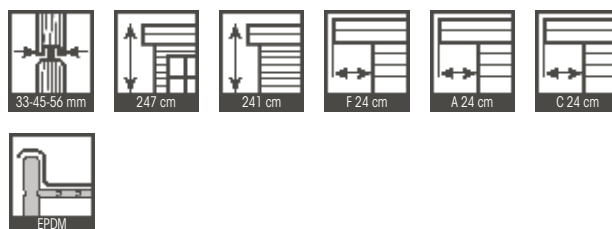

MATTIS

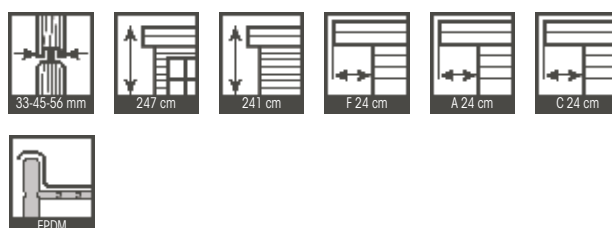
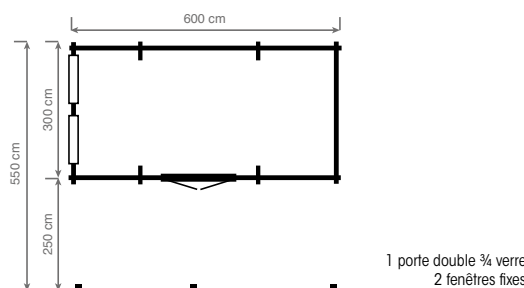

COSMOS

MARGARITA

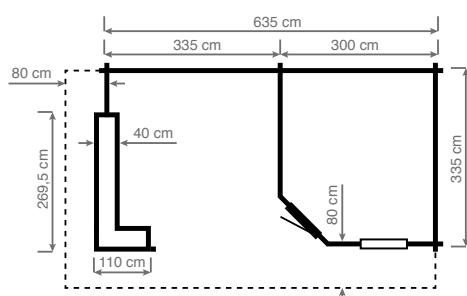

1 porte simple d'angle en verre dépoli, 1 fenêtre VRL fixe avec verre dépoli

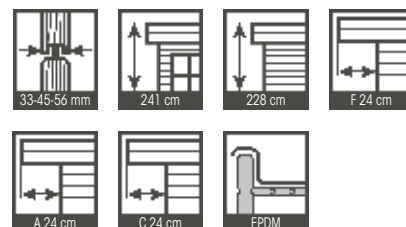

KONYA

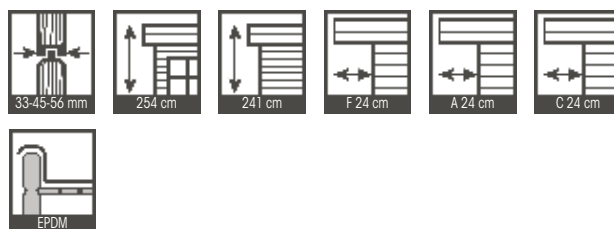
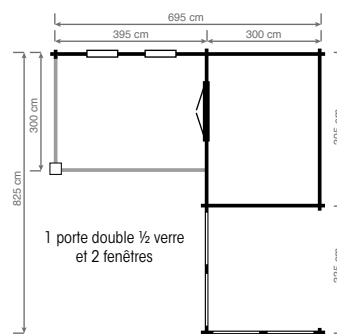

SAMSUN

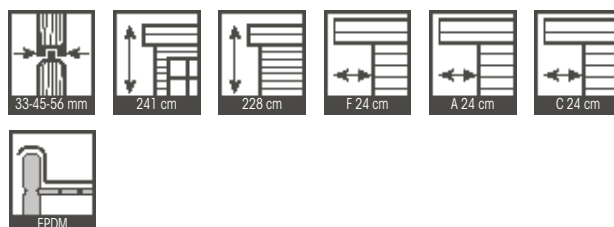

DENZILI

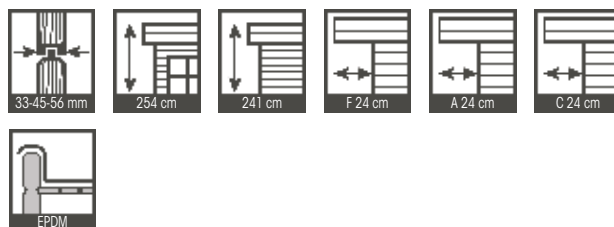
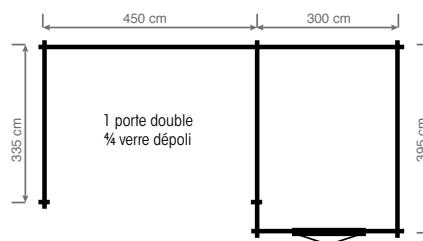

COSMOS



MALIFARU

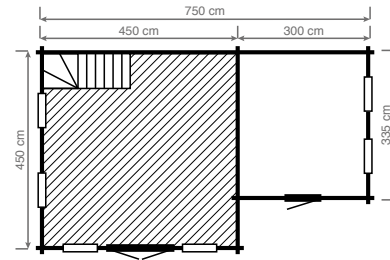

1 double et 1 simple ¼ porte verre dépoli, 5 fenêtres fixes verre dépoli VRV et 2 fenêtres basculantes VRC

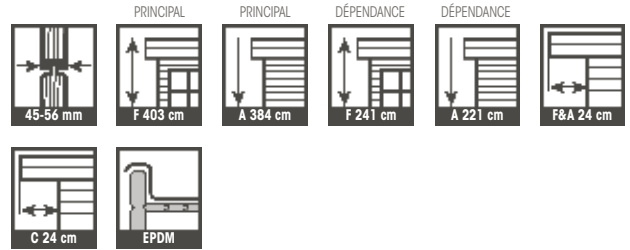

DUVARI

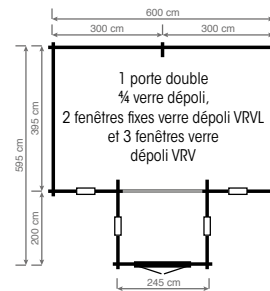

1 porte double ¼ verre dépoli, 2 fenêtres fixes verre dépoli VRVL et 3 fenêtres verre dépoli VRV

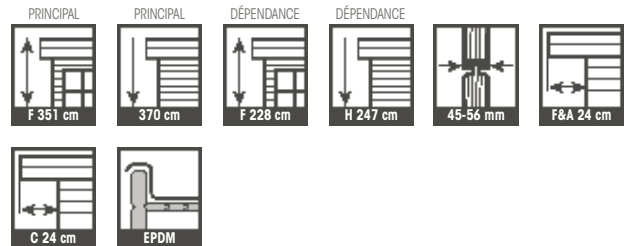

MELAMU

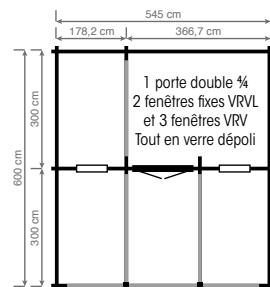

1 porte double ¼ et 2 fenêtres fixes VRVL et 3 fenêtres VRV
Tout en verre dépoli

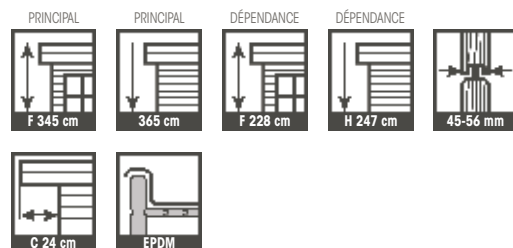



UN TRAVAIL SUR MESURE EN 3 ÉTAPES



1

VOTRE IDÉE

Tout commence avec votre idée de la construction de vos rêves. Notre catalogue peut vous aider à trouver l'inspiration. Vous pouvez faire quelques dessins et/ou croquis.



2

CONTACTEZ LE POINT DE VENTE LE PLUS PROCHE

Prenez contact avec le point de vente de votre région. Vous pouvez nous rendre visite pendant les heures d'ouverture ou prendre rendez-vous avec un de nos conseillers.



3

VOTRE DEVIS PERSONNALISÉ

Notre expert traduira vos souhaits de façon technique et évaluera la faisabilité de votre projet. Sur la base de cet entretien, il vous remettra un devis personnalisé du projet de vos rêves.

**DU SUR-MESURE À
DES PRIX STANDARDS**

- ✓ UN CERTIFICAT D'AUTHENTICITÉ
- ✓ AUCUN PRODUIT VIENT D'EUROPE DE L'EST, C'EST GARANTI
- ✓ UNE GARANTIE DE 10 ANS SUR LES DÉFAUTS DE PRODUCTION ET/OU DE FABRICATION

MIMAS





MIMAS

Le projet Mimas à été réalisé par Top-Cottage il y a quelques années. Une réponse à la croissance d'expérience de la vie en plein air. Le jardin est de plus en plus un espace de vie supplémentaire.

AVANTAGES

- Sous-toiture : planches 19 mm avec languette/rainure
- Gouttières avec descente inclus
- Couverture du toit : EPDM, 400% élastique
- Gamme portes et fenêtres contemporaine, pleine ou vitrée (clair ou dépoli)
- Puit de lumière en verre de sécurité en polycarbonate trempé, haute résolution du bruit (-39 db)

OPTION: puit de lumière



MIMAS

MIMAS 1200

fenêtre dans le lounge en option

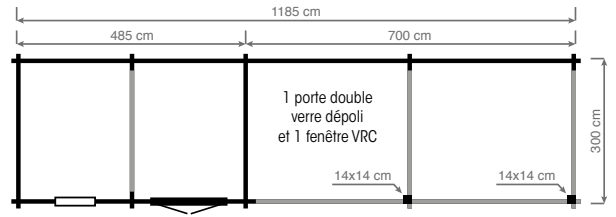

MIMAS PLUS

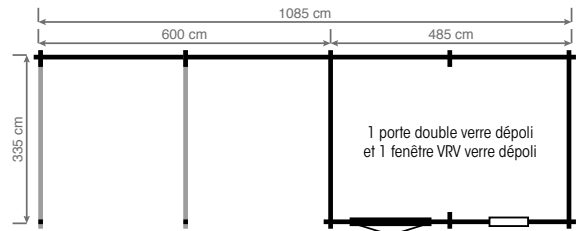

MIMAS CLASSIC

mur à coté en option

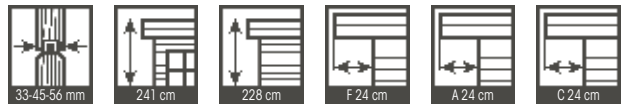
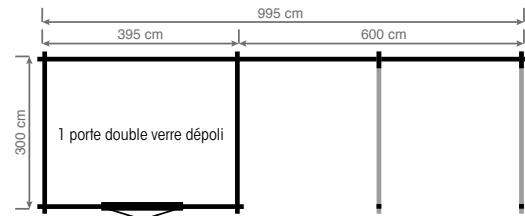

MIMAS 800

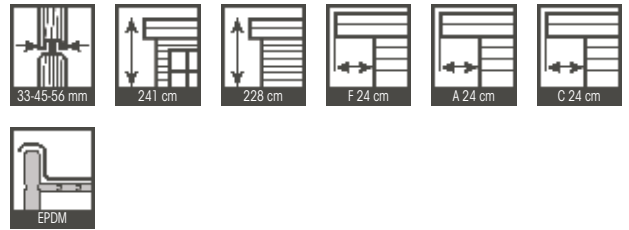
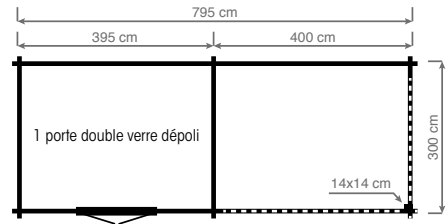

MIMAS 700

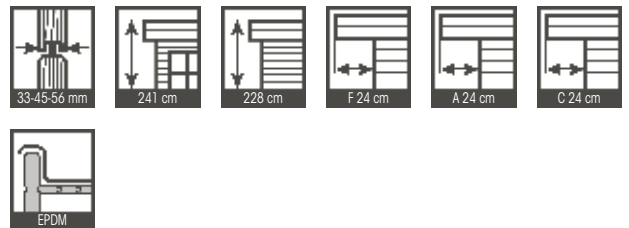
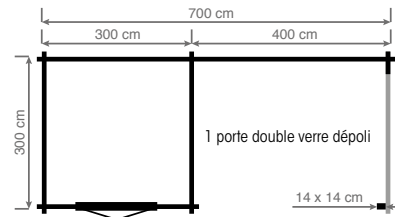

MIMAS 600

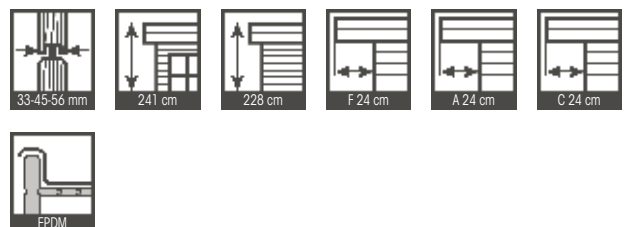
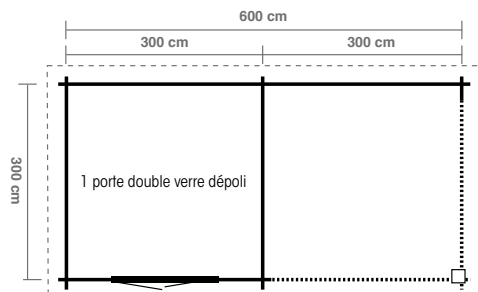

MIMAS

MIMAS 500

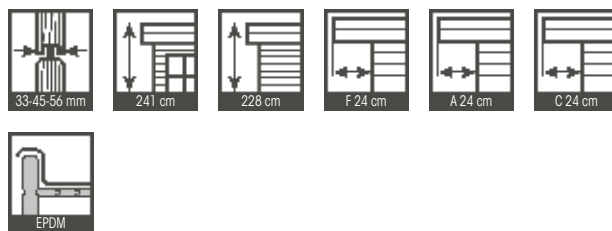
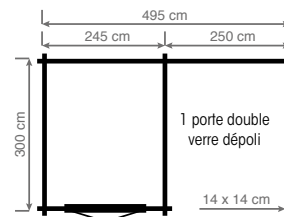

MIMAS PINAR

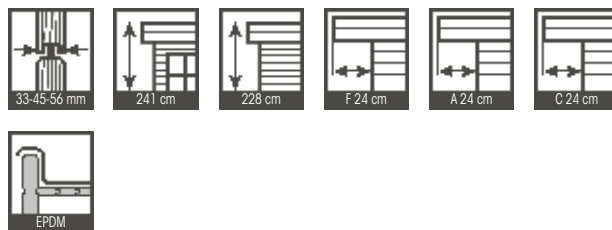
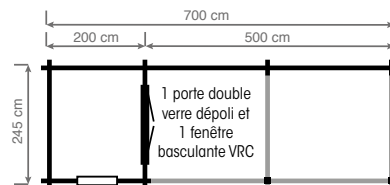

MIMAS EURA

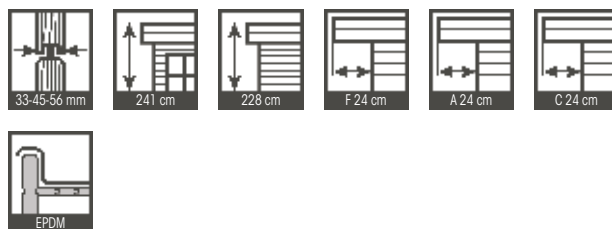
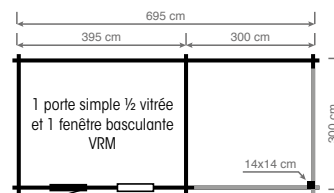

MIMAS GAUDI

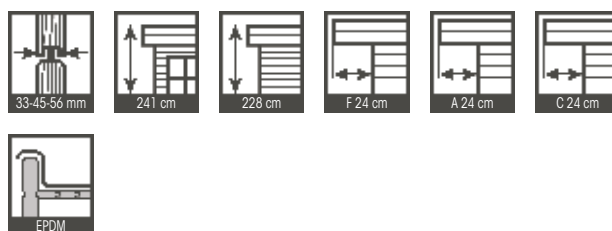
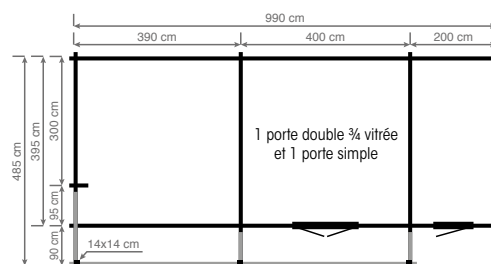

MIMAS GOYA

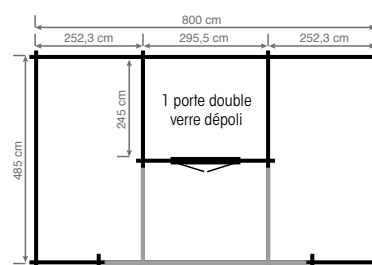

MIMAS ROCCA

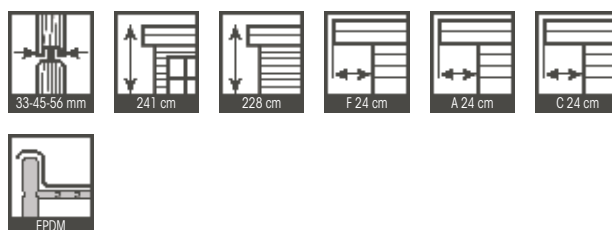
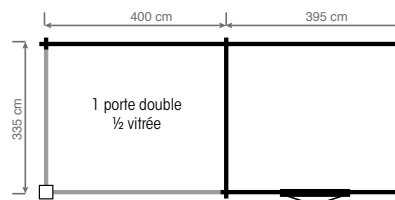

MIMAS

MIMAS MONET

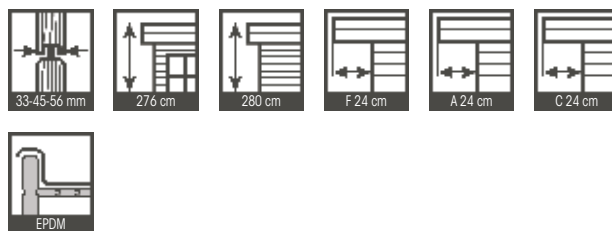
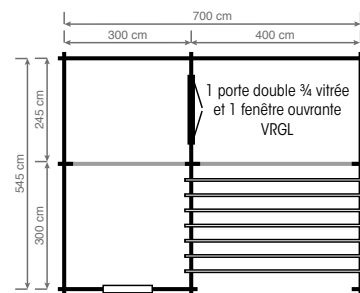

MIMAS ROYAL

avec un store vénitien

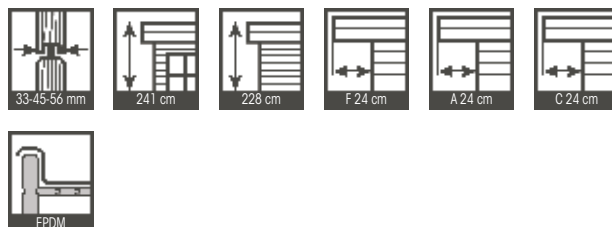
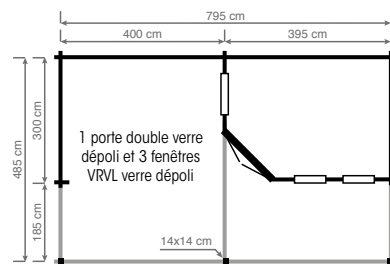

MIMAS DAHLI

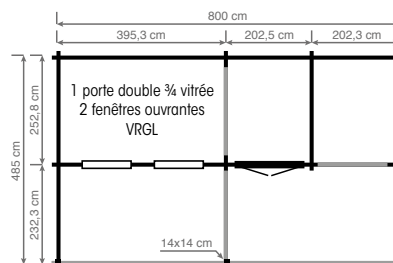

MIMAS GIGOT

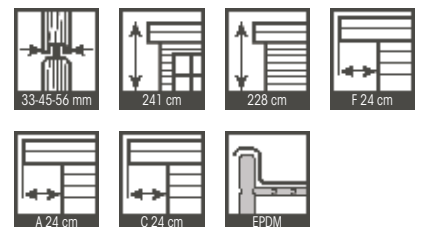
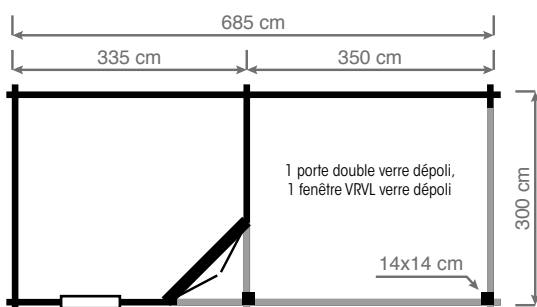

COTTAGE & COUNTRY





COTTAGE & COUNTRY

Nous avons développé plusieurs modèles pour vous dans le style des maisons anglaises, finition en bois de chêne optionnelle.

Notre système d'emboîtement nous permet de créer un alternatif, à bon prix, pour ses cabanes et maisons authentiques. Evidemment on vous propose une finition en bois de chêne, qui donnera à votre construction une valeur ajoutée avec beaucoup de présence.

Bien entendu, toutes les constructions sont livrables, si techniquement possible.

AVANTAGES

- Pente de toit de 42° avec toiture à 2 pans avec croupe
- Portes surélevées (196 cm) en exécution standard
- Vaste assortiment de fenêtres et portes avec, toujours, du verre authentique
- Nombreuses possibilités d'extension : standard shingles (4 types) et finition toiture de chaume exclusive
- Options: finition chêne pour les auvents et patio au moyen des poutres en chêne 14 x 14 cm et des supports



OPTION: finition chêne



COTTAGE & COUNTRY



Façade:	1 - 30 m
Profondeur:	1 - 6 m
Hauteur:	3,18 - 4,98 m
Fenêtres:	
Portes:	



COTTAGE & COUNTRY BASIC



OPTION: poutres en chêne avec des étais assortis



Configurations possibles

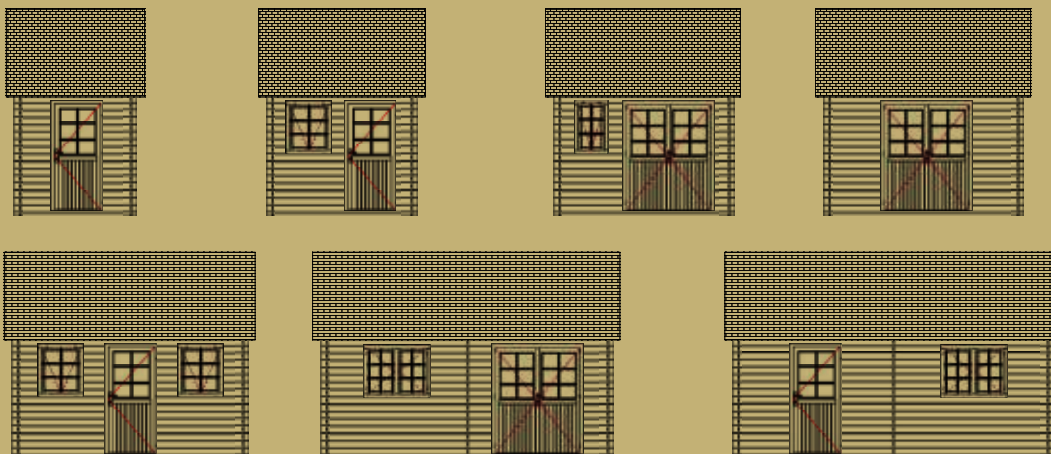

COTTAGE & COUNTRY

ORCHILA

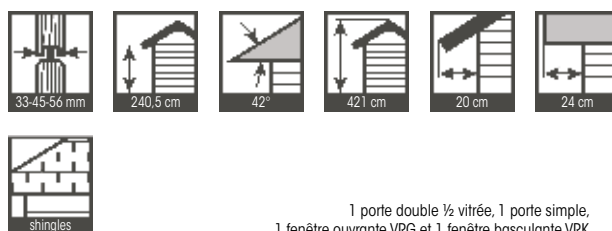
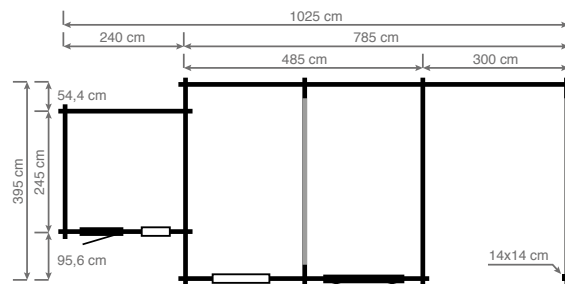

1 porte double ½ vitrée, 1 porte simple,
1 fenêtre ouvrante VRG et 1 fenêtre basculante VRK

MONTSERRAT

volets et set de gouttières zinc en option

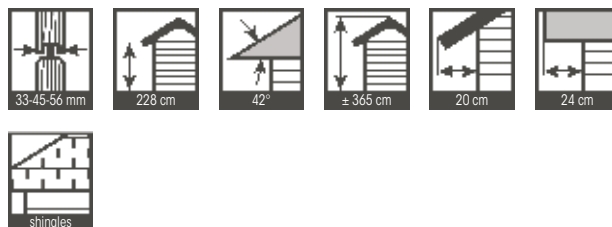
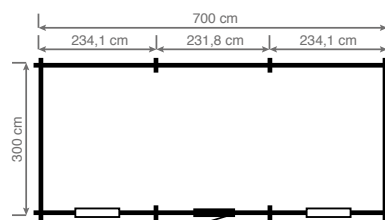

1 porte simple ½ vitrée et 2 fenêtres VRG

SANTA LUCIA

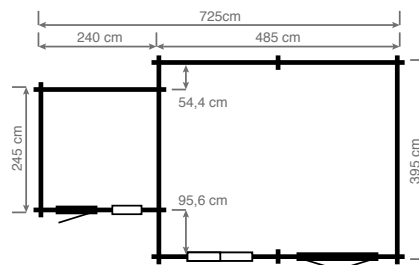

1 porte double ½ vitrée, 1 porte simple,
1 fenêtre ouverte VRG et 1 fenêtre basculante VRK

FLINT

piédestal en option

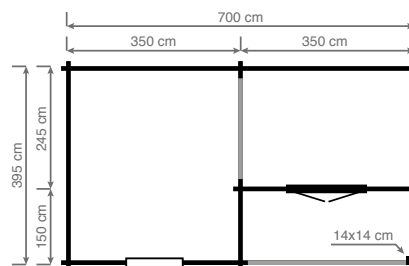

1 porte double 1/2 vitrée et 1 fenêtre basculante VRI

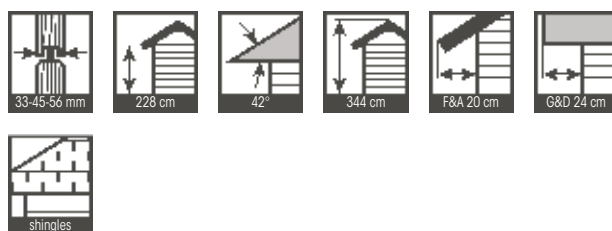

ARNOLD

panneaux de tuiles pas inclus

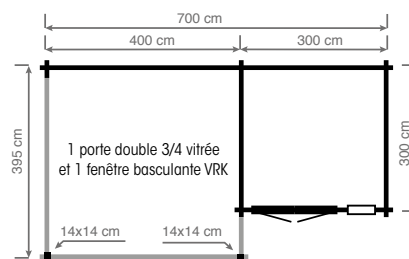

1 porte double 3/4 vitrée et 1 fenêtre basculante VRK

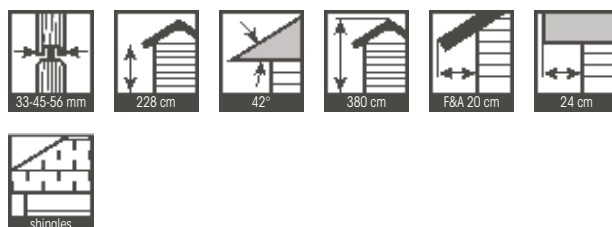

LANELLI

set de gouttières en option

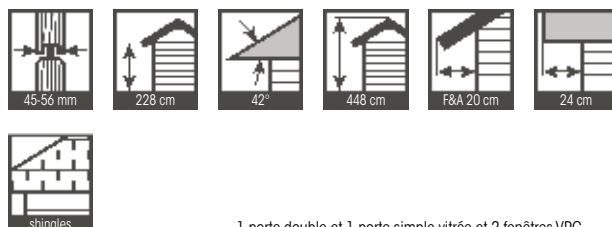
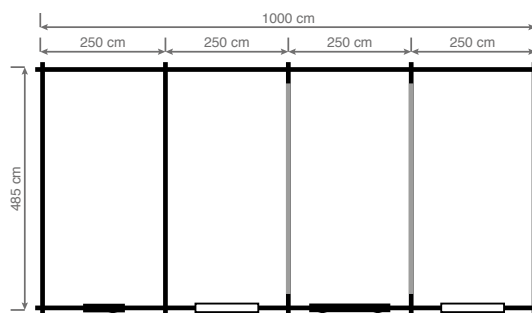

1 porte double et 1 porte simple vitrée et 2 fenêtres VRG

COTTAGE & COUNTRY

FINI

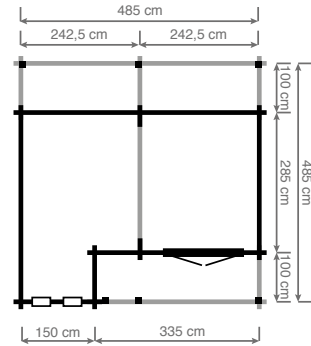

1 porte double pleine et 2 fenêtres basculantes VRS

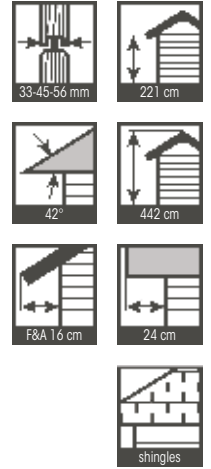

GRINTA

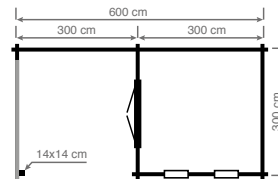

1 porte double 1/2 verre et 2 fenêtres basculantes VRK



GOMERA

set de gouttières en option

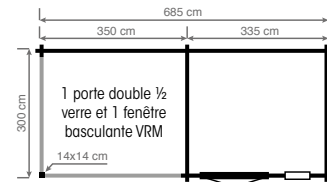

1 porte double 1/2 verre et 1 fenêtre basculante VRM

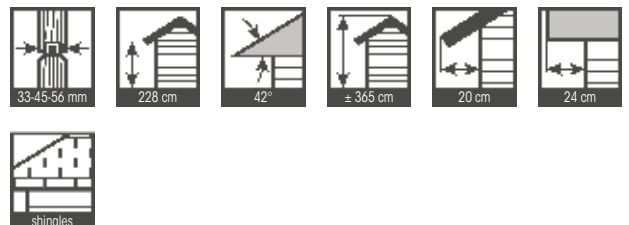

NELSON

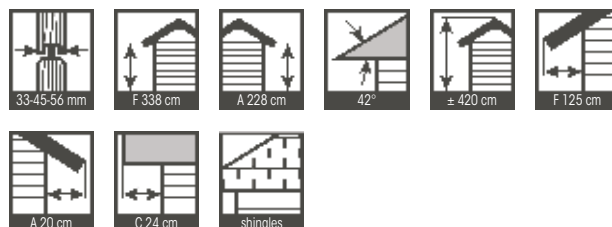
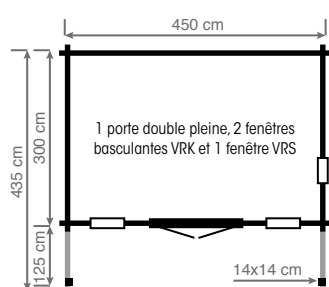

COTTAGE & COUNTRY

REDON

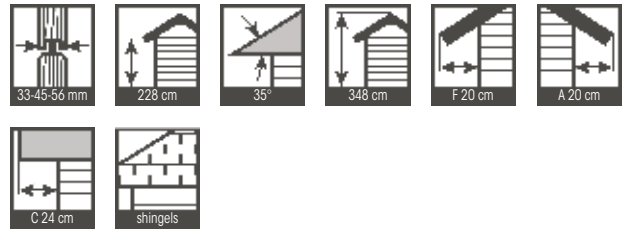
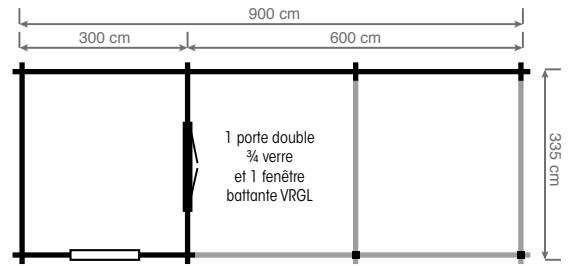

CASTEL

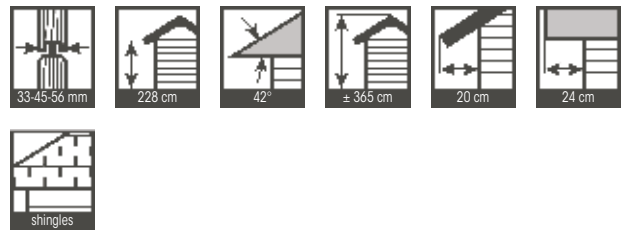
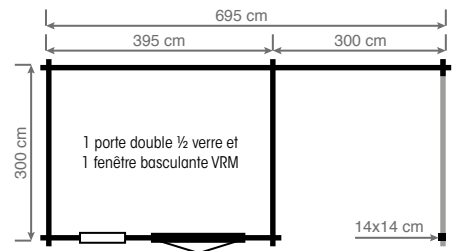

TORTEVAL

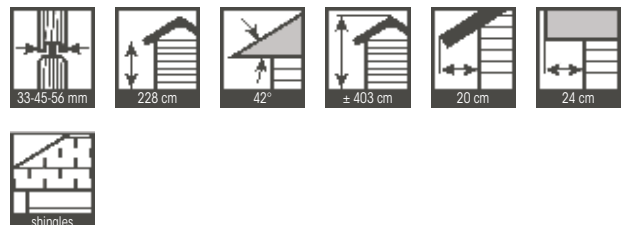
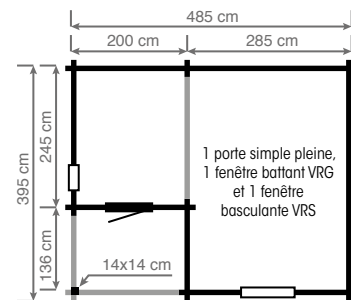

CONWY

Set de gouttières en option

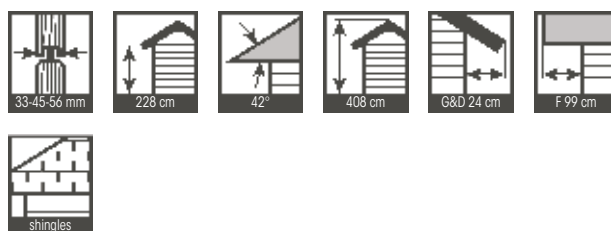
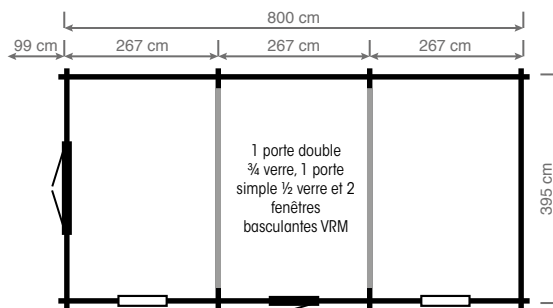

MANO

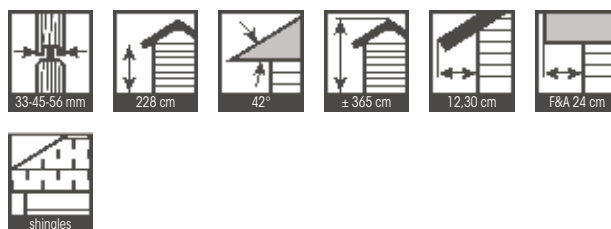
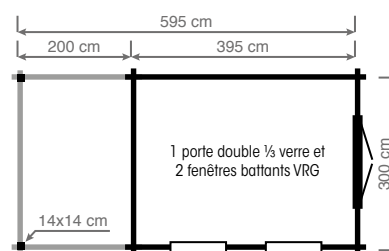

GLENAN

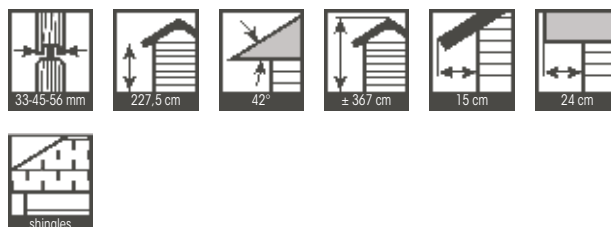
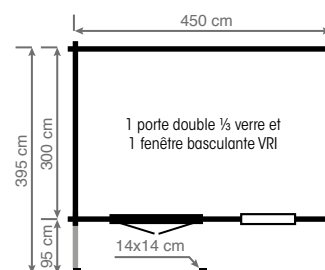

COTTAGE & COUNTRY

GAVRINIS

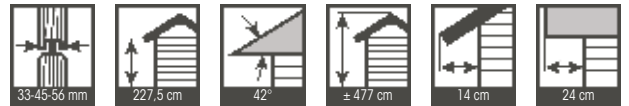
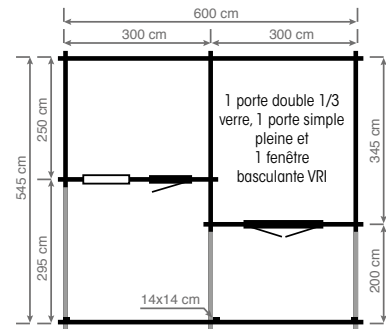

MALBAN

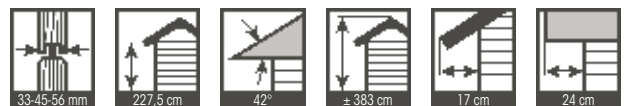
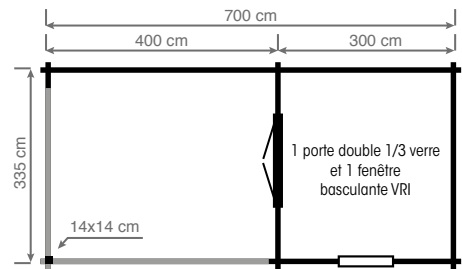



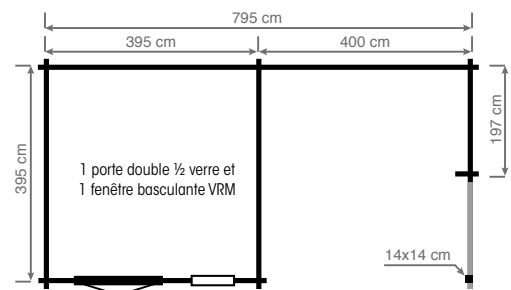



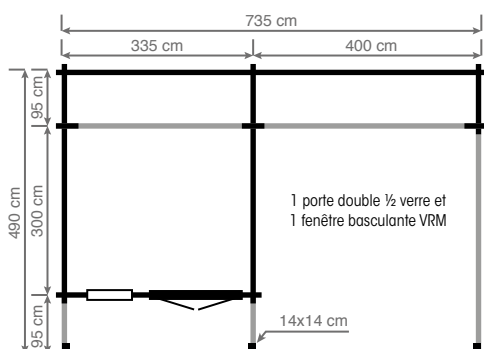

CASTILLE



JERSEY



 33-45-56 mm	 F 221 cm	 A 143 cm	 42°	 ± 410 cm	 F 130 cm
 A 20 cm	 C 24 cm	 shingles			

COTTAGE & COUNTRY

QUEBERON

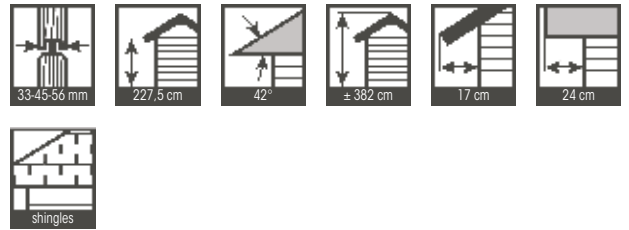
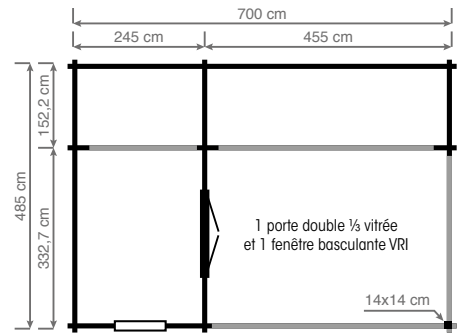

MICHEL

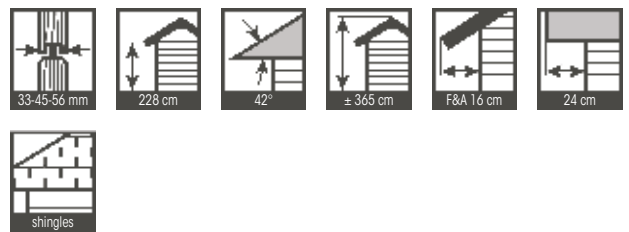
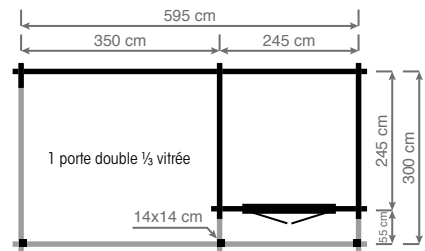

GAUTHIER

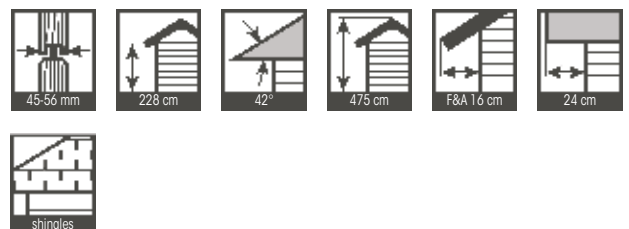
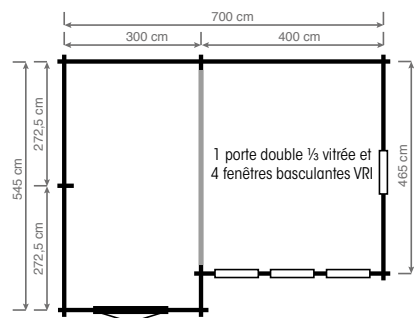

LOCRONAN



Annexe à droite pas inclus

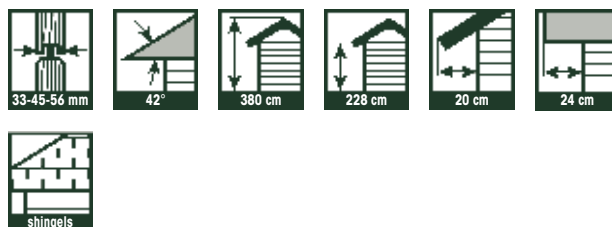
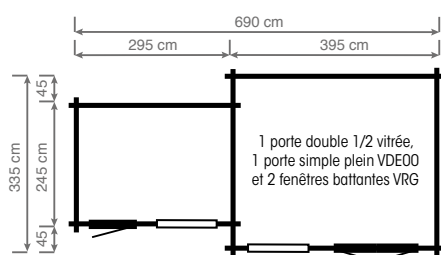

COTTAGE & COUNTRY

AGANTON

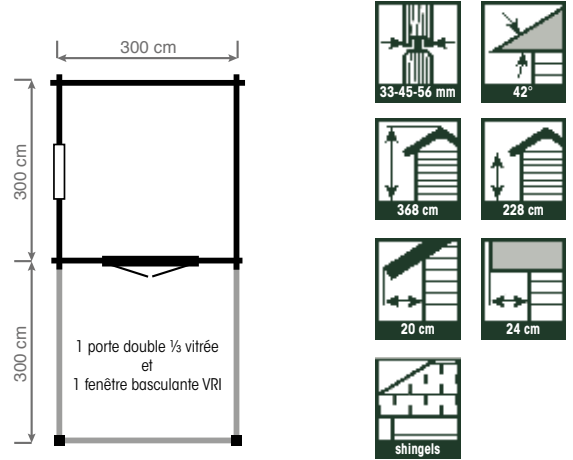

FOUGERE

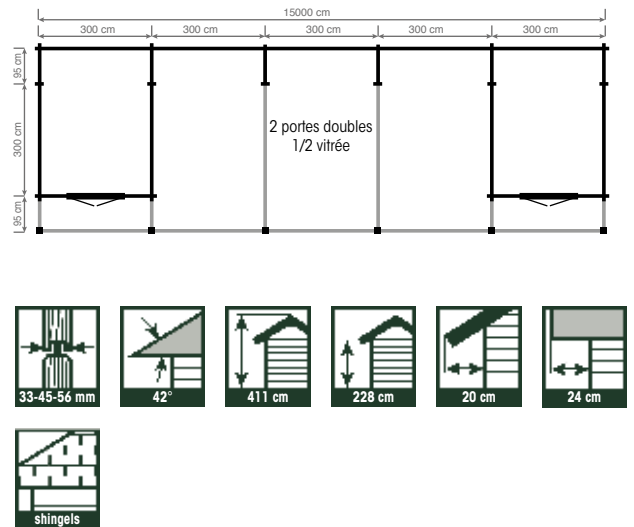

ZINGA

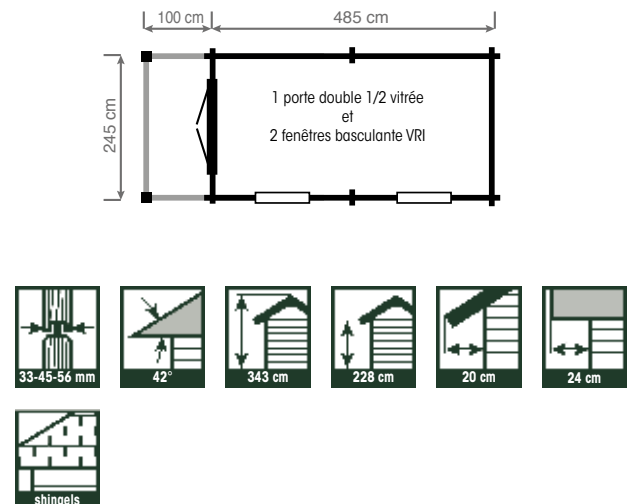





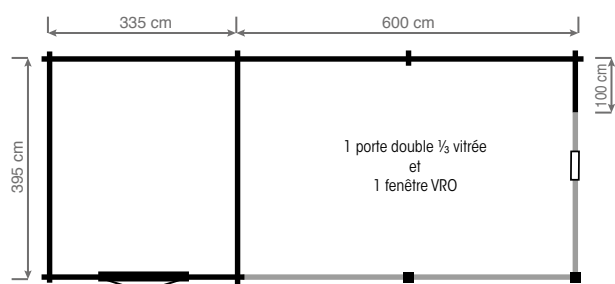

OREAN



set gouttières zinc en option



 33-45-56 mm	 42°	 424 cm	 241 cm	 20 cm	 24 cm
 shingels					

GRANGES





GRANGES

Nos pavillons déplacent votre séjour à l'air libre! Ils sont toujours fabriqués avec du bois d'épicéa de qualité et sont fournis avec un certificat d'authenticité !

Un pavillon Grandcasa peut également servir de carport ou de remise.

A vous le choix!

Le pavillon est généralement utilisé comme séjour extérieur, où il fait bon de se détendre en été comme en hiver !



AVANTAGES

- Toit asymétrique 19 - 34°
- Chevrons ouverts rustiques
- Épaisseurs de bois 33, 45, 56 mm
- Poteaux de soutien massifs de 14 x 14 cm
- Grand choix de revêtements de toit : shingles (4), panneaux profilés métalliques (4), panneaux de tuiles métalliques (5)
- En option : finition exclusive avec des panneaux de toit en chaume

GRANGES

ROSCOFF JUNIOR

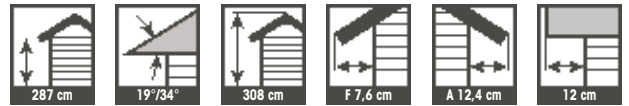
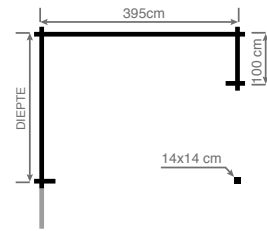

Disponible de 200 cm jusqu'à 485 cm de profondeur

ROSCOFF SENIOR / MASTER

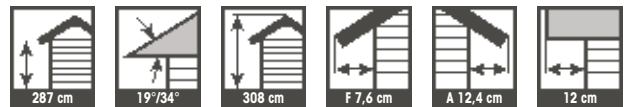
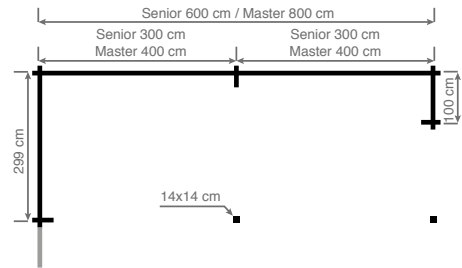

CROZON

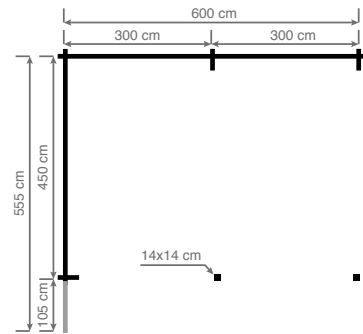

TREBERON

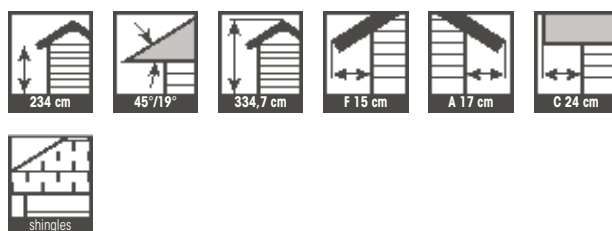
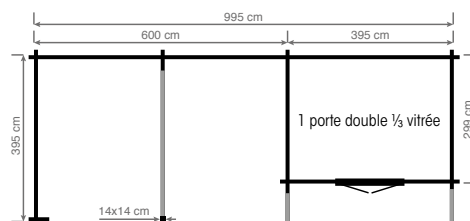

BÉNODET

porte simple en option

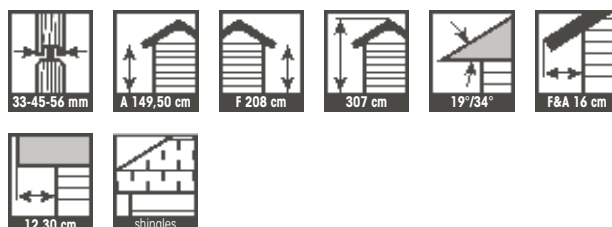
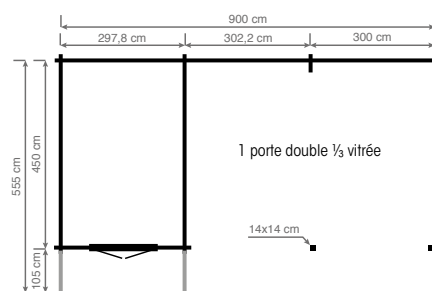

BATZ

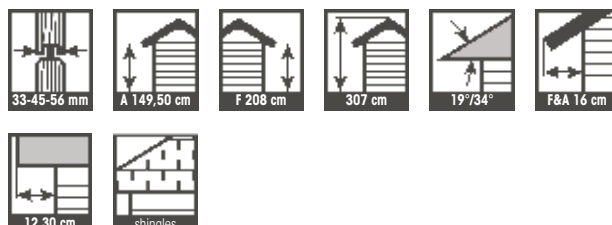
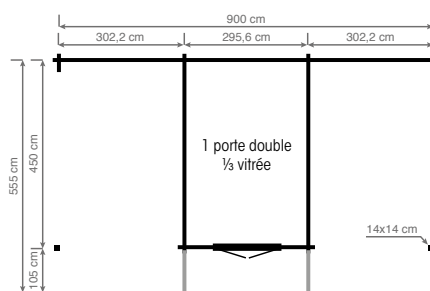

GRANGES

BERBER

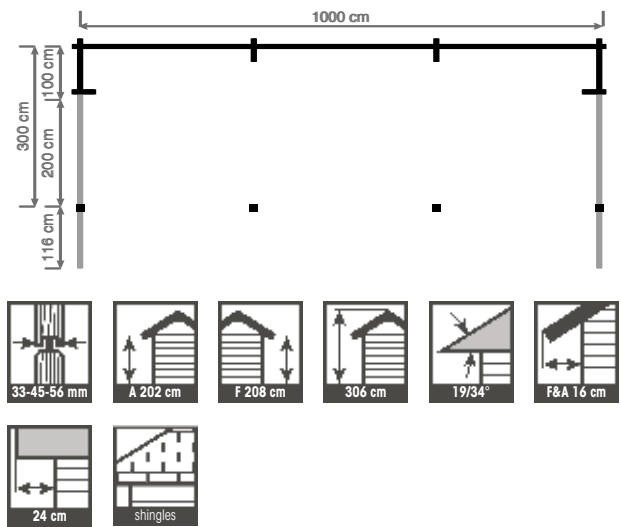

BRÉHAT

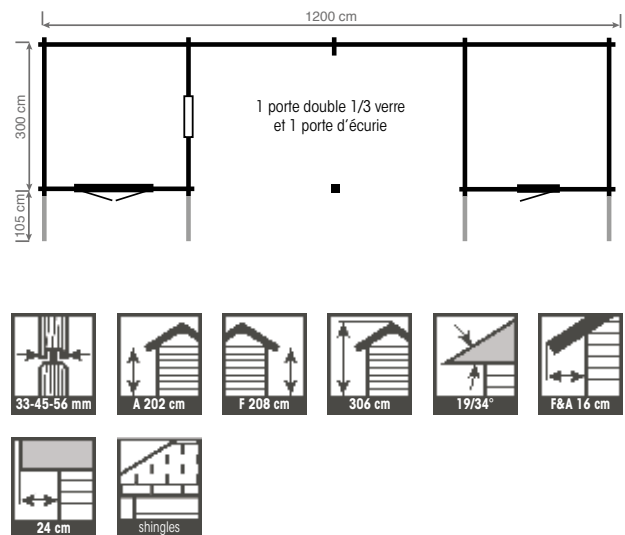



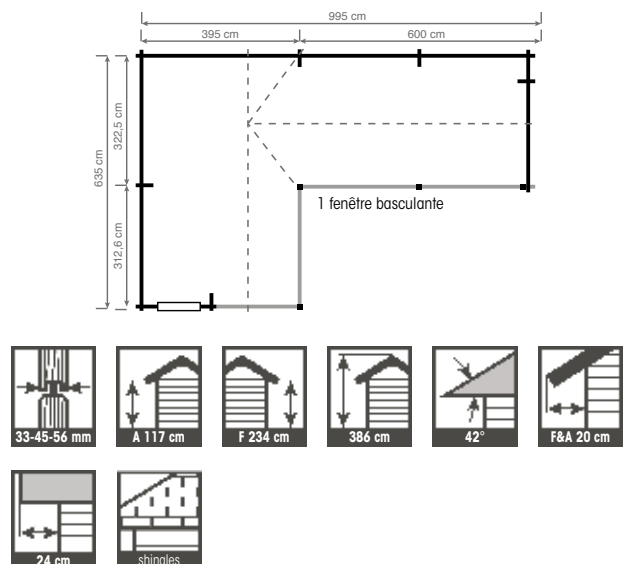



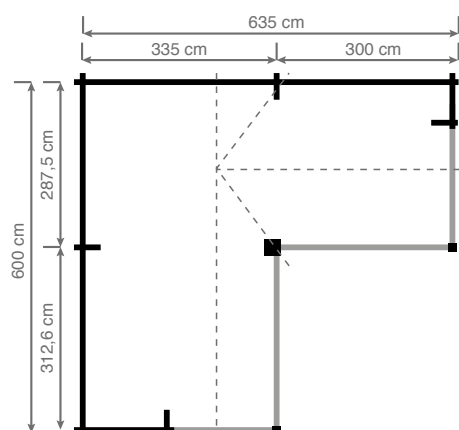

CALLOT



PAON



 33-45-56 mm	 208 cm	 42°	 278 cm	 F 24 cm	 A 24 cm
 16 cm	 shingles				

FENÊTRES ET PORTES

COMFORT LINE

AVANTAGES

- Porte laminée et soudée, ce qui neutralise l'effet naturel du bois (1)
- Fenêtres et portes rotatives vers l'extérieur
- Verre authentique de 4 mm d'épaisseur collé dans l'encadrement, avec de la silicone (2)
- Paumelles réglables intégrées (3)
- Petits-bois décoratifs
- Fenêtres avec garniture solide en aluminium
- Portes avec poignée massive en RVS (4)
- Portes doubles avec verrous à bascule intégrés
- Portes surélevées : 1960 mm (5)
- Possibilité de double vitrage 4-6-4 mm (6)
- Toutes les portes et fenêtres sont équipées de caoutchoucs d'étanchéité

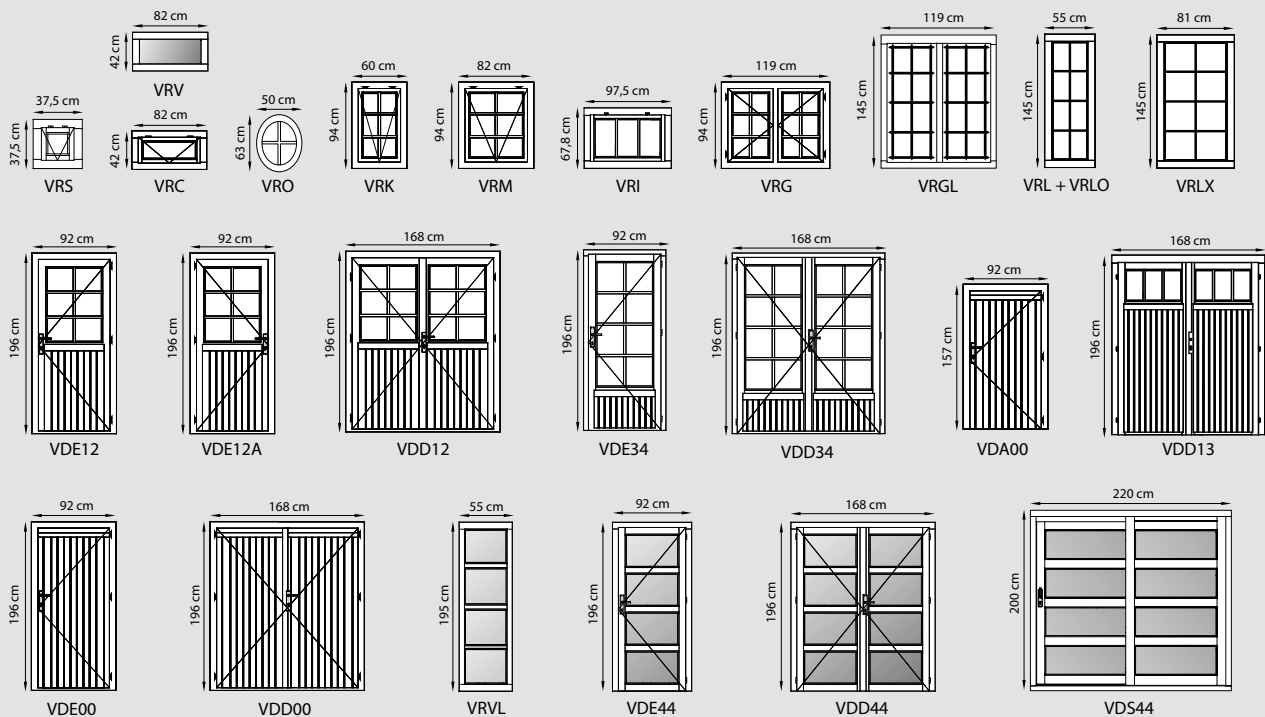

PREMIUM LINE

Super isolé et possible dans toutes nos constructions • qualité pour chalets de loisirs

AVANTAGES

- Fenêtres s'ouvrent vers l'intérieur
- Portes s'ouvrent vers l'extérieur
- Volets robustes disponibles en option, sur toutes les fenêtres et portes (1)
- Toutes les portes et fenêtres sont équipées de caoutchoucs d'étanchéité
- Petits-bois livrés en paquet. A installer librement
- Double vitrage de 4 - 16 - 4 mm prévu partout (2)
- Les panneaux de portes en bois sont équipés d'une isolation de 4 cm
- Serrure à cylindre avec fermeture à 3 points (3)
- Portes avec 4th charnière au sommet (4)
- Fenêtres ouvrantes sans pilier central (5)



2



3



VOLETS

- Volets robustes optionnel (porte 22 mm, fenêtre 18 mm)
- Encadrement de porte 55 x 93 mm
- Charnières renforcées en forme de L, en acier peint
- Verrouillables de l'intérieur



1



1



MLH

- Bois multi-stratifié
- Minimise le fonctionnement naturel du bois
- Liaison hautement qualitative: résistant à l'eau

PLUS GRANDE STABILITÉ

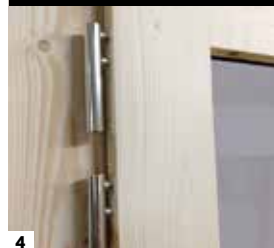

4

PLUS DE VISIBILITÉ



5

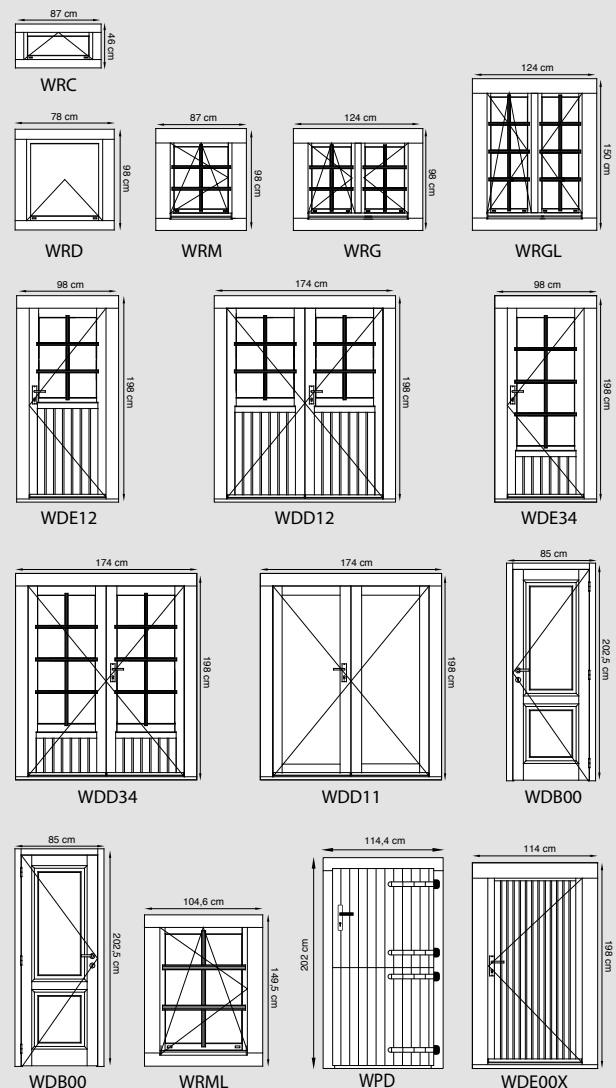



FENÊTRES ET PORTES

- ✓ **Vitrage isolant 4-16-4, Low-E;**
valeur $U_g = 1,1 \text{ W/m}^2\text{K}$
- ✓ **Isolation acoustique**
- ✓ **Parfaitement étanche à l'air et à l'eau**



SUPREME LINE ALUMINIUM

Gamme de fenêtres et portes en aluminium de qualité, avec système de cadre et pont de rupture thermique, coloris anthracite.

AVANTAGES

- Look industriel, valeurs U de 1,96 à 1,33 $\text{W/m}^2\text{K}$
- Petits-bois décoratifs de 23,1 mm sur le vitrage.

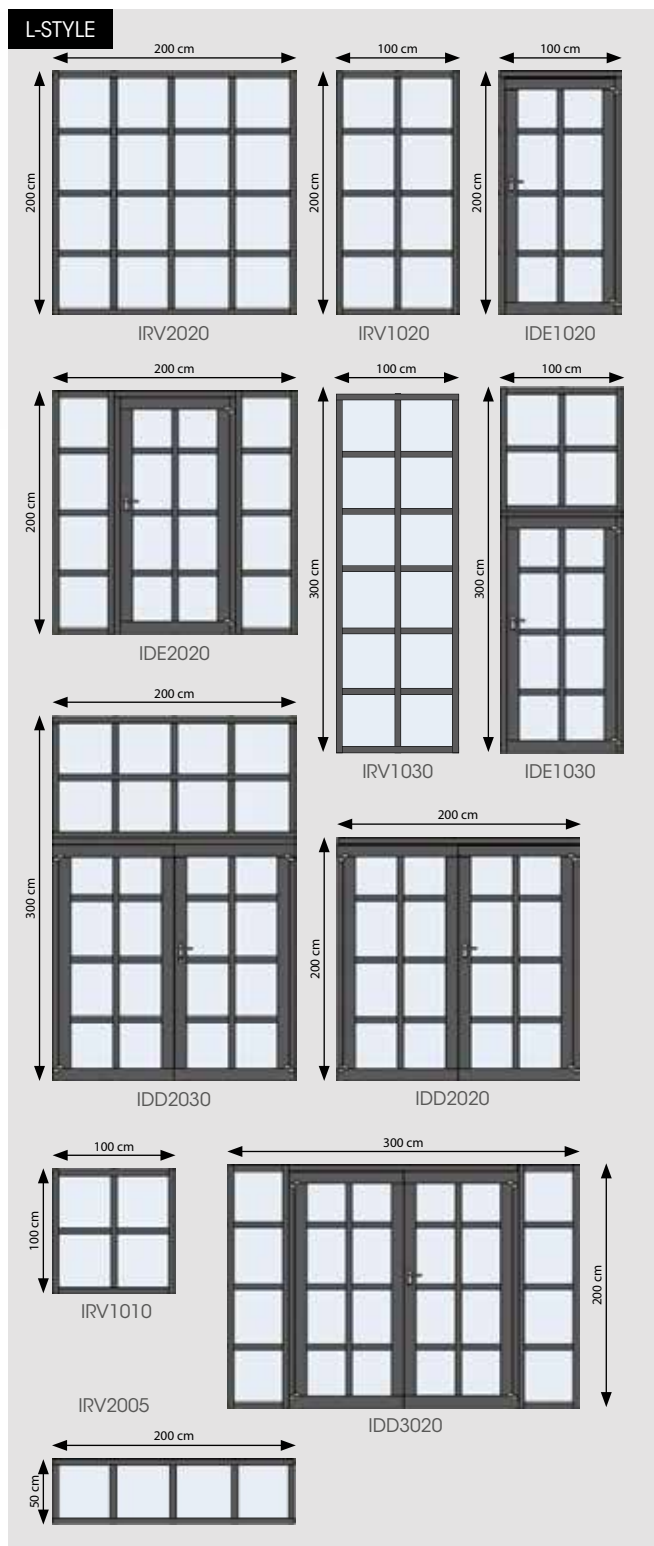



AVANTAGES

- Portes coulissantes et baies vitrées spacieuses avec vitrage isolant 9-16-4
- Poignées de porte et charnières également dans le ton anthracite
- Portes coulissantes avec mécanisme de coulissement, fermeture automatique et système contre les déformations



A-STYLE

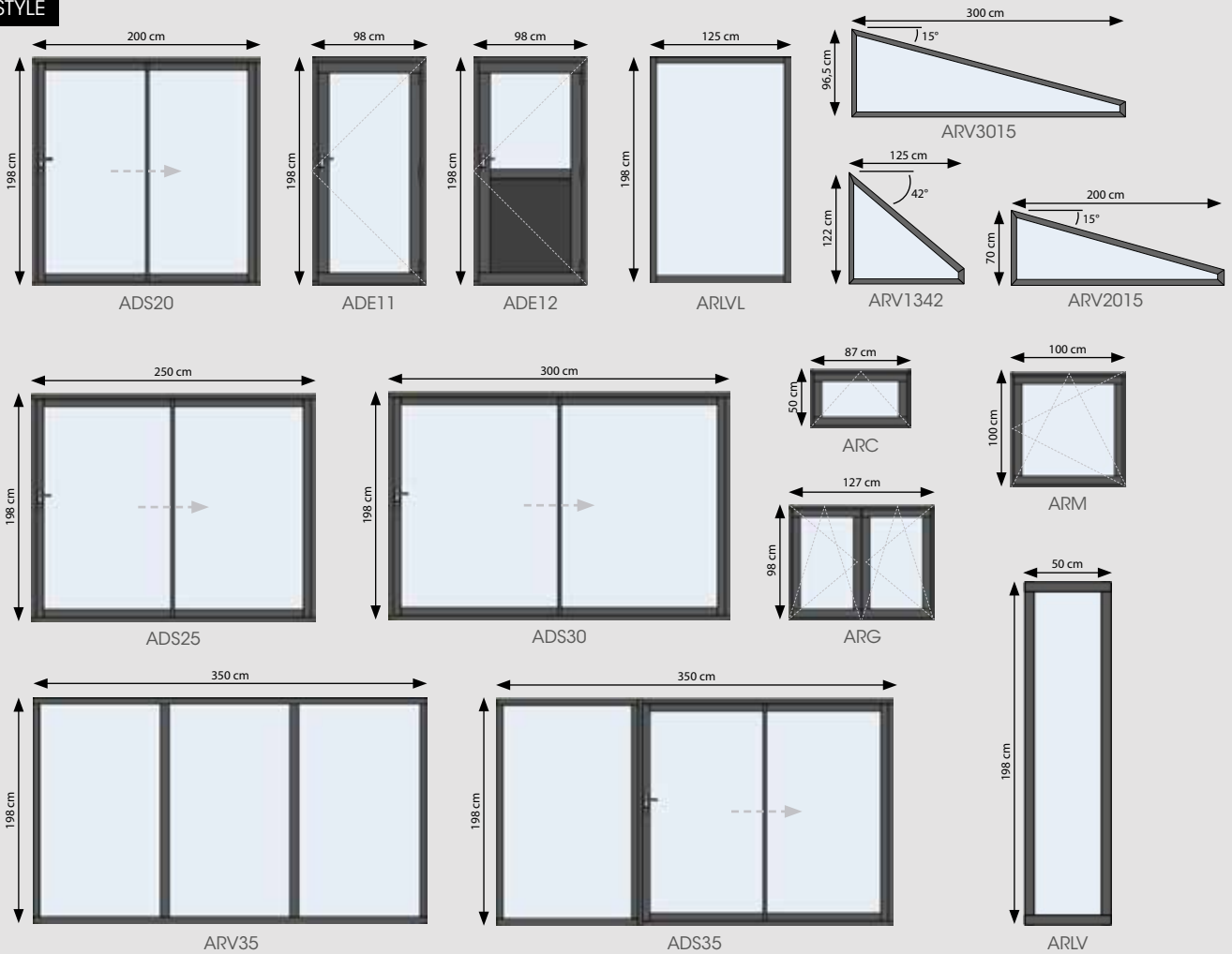

ROYAL





ROYAL

Soif de prestige, d'exclusivité, de luxe?
Notre gamme Royal est faite pour vous.
Le toit pyramidal très distingué des abris de
jardin Royal crée en effet un look royal.
Ces modèles sont aussi équipés en
standard de portes 3/4 vitrées, combinées
avec des fenêtres de la série VRL, raffinées
elles aussi.
Ces combinaisons garantissent un
rayonnement raffiné et distingué.



AVANTAGES

- Toit pyramidal avec solives de 38 x 89 mm et de 33 x 145 mm, sous-toit avec planches massives de 19 mm et pré-assemblé en 8 parties
- Toiture : choix parmi pas moins de 4 variétés de shingles (vert, brun, noir, rouge)
- Possibilité d'exécution avec porte d'angle

ROYAL BASIC



Façade:	1 - 30 m
Profondeur:	1 - 6 m
Hauteur:	2,67 - 3,45 m
Fenêtres:	
Portes:	

ROYAL BASIC



OPTION: porte coulissante



OPTION: porte d'angle



Configurations possibles

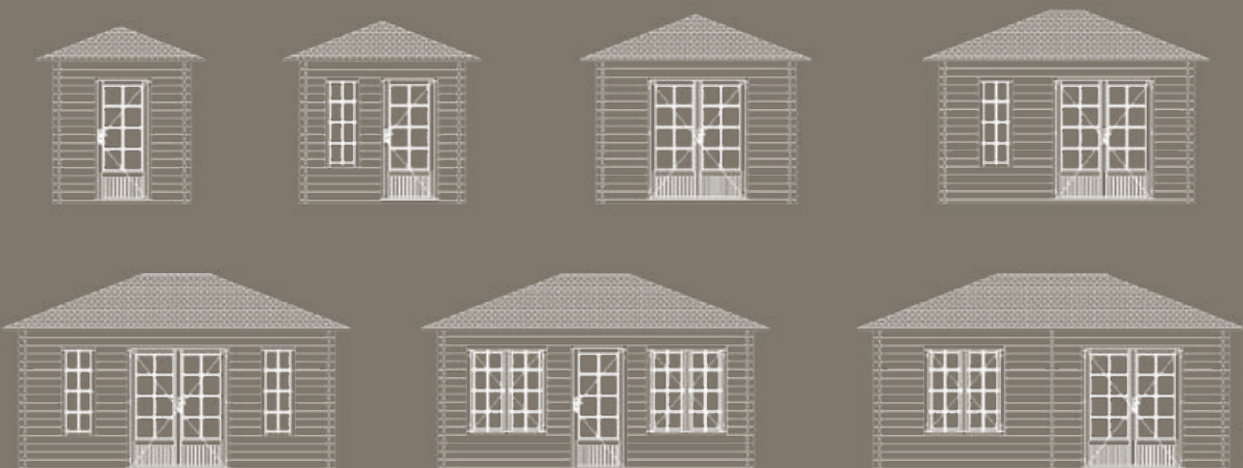

ROYAL

ALBA

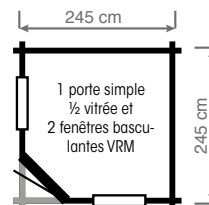

ARTHUR

set de gouttières en option

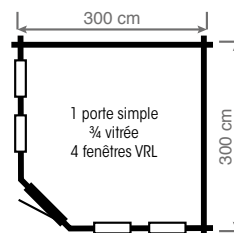

Porte d'angle, supportée par 2 profiles robustes (150 x 100 mm)

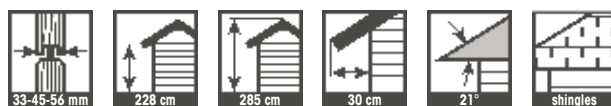

GEORGE

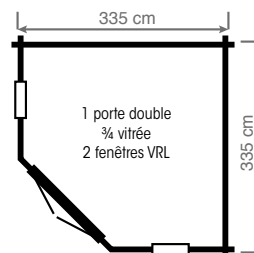

Porte d'angle, supportée par 2 profiles robustes (150 x 100 mm)



ACAPULCO

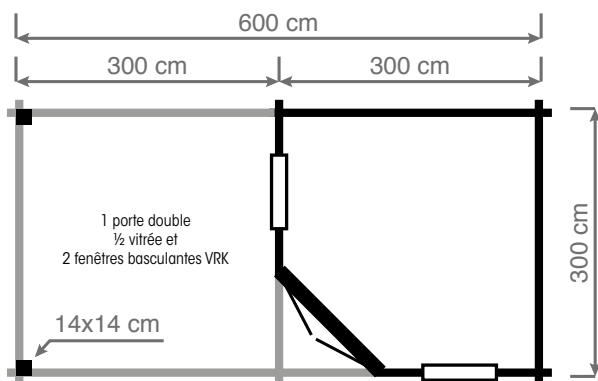

ROYAL

TORTUGA

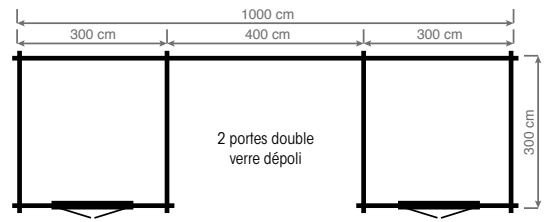

Terrasse couverte 400 x 300 cm

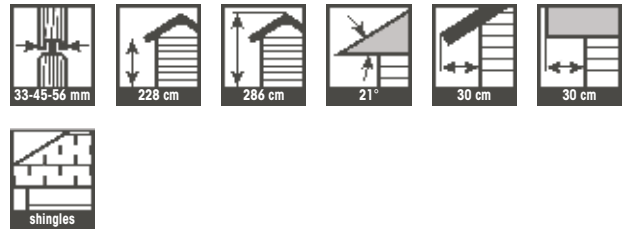

MERIDA

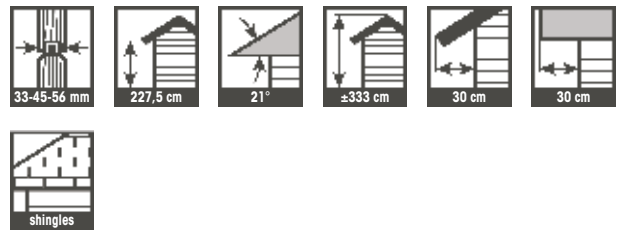
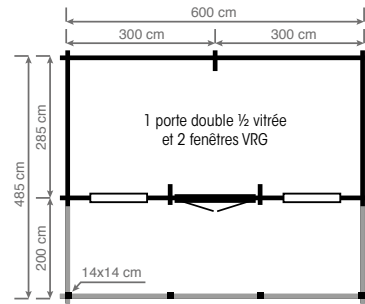

ORINOCO

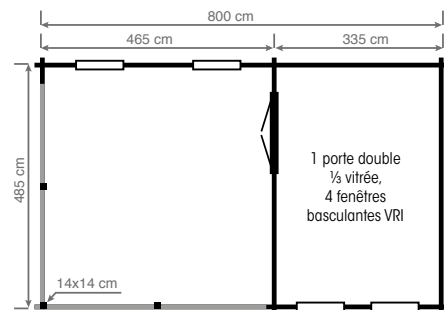

CALUMMA

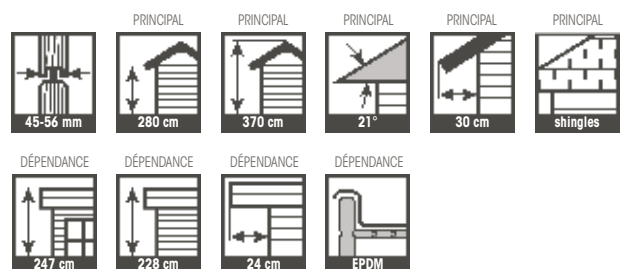
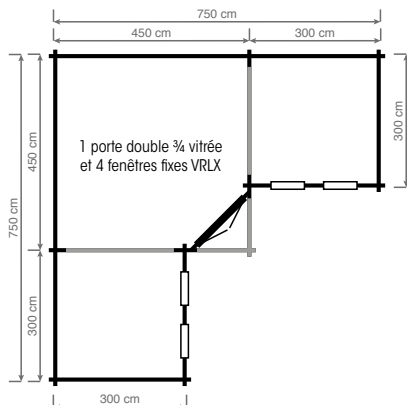

ROYAL

BONORI

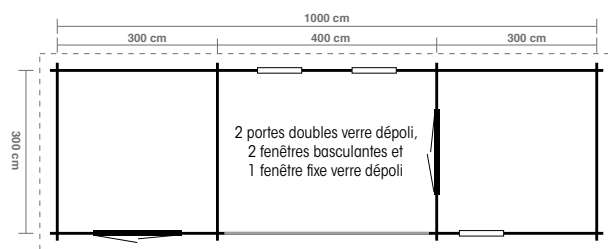

YUCATAN

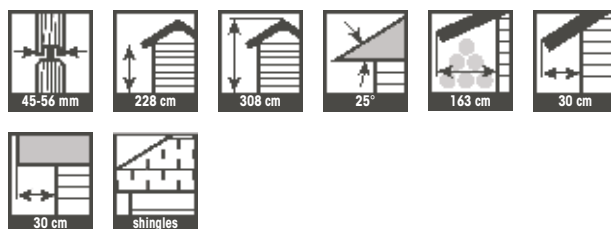
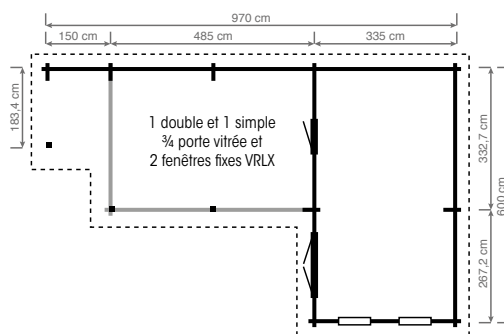

HIDALGO

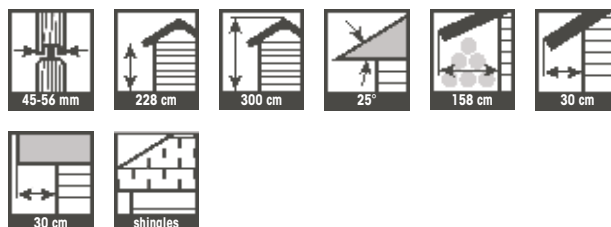
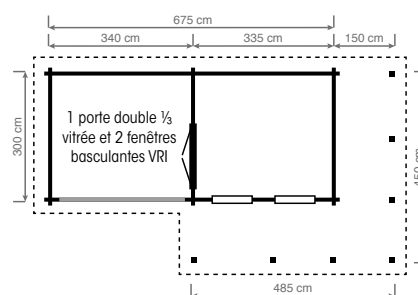

ANGUILLA

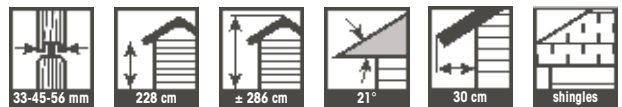
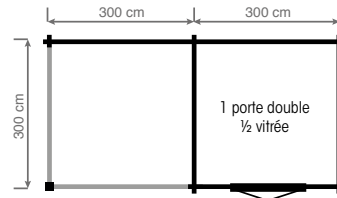

GALLEROSA

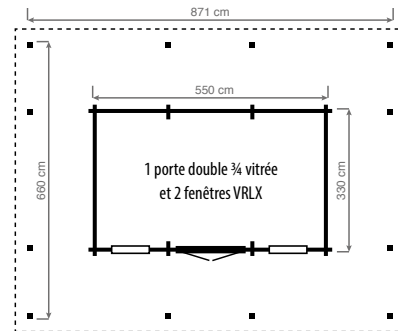

• Autour, terrasse couverte 195 cm, fourni avec poutres de support 14 x 14 cm



CURACAO

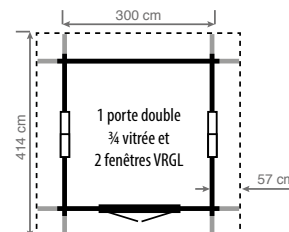



PEFCTM

PEFC/07-31-200

POUR LA GESTION DURABLE DES FORÊTS

Le **Programme de reconnaissance des certifications forestières** (PEFC) est une certification forestière promue par **PEFC International**, organisation non gouvernementale sans but lucratif, fondée à Paris en 1999 et dont le siège est situé à Genève. Il a pour objectif de promouvoir la gestion durable des forêts au travers d'une certification indépendante. Celle-ci concerne en tout deux tiers des forêts certifiées dans le monde. Plus de 15 millions de propriétaires forestiers privés ont adhéré à cette convention.

Tout notre bois est certifié PEFC, ce qui implique que le bois de votre construction provient de forêts où, chaque année, le nombre d'arbres abattus est inférieur au nombre d'arbres plantés. En outre, le label PEFC exige le respect de huit conventions centrales de l'OIT :

- N° 29 sur le travail forcé (1930)
- N° 87 sur la liberté syndicale et la protection du droit syndical (1948)
- N° 98 sur le droit d'organisation et de négociation collective (1949)
- N° 100 sur l'égalité de rémunération (1951)
- N° 105 sur l'abolition du travail forcé (1957)
- N° 111 concernant la discrimination (emploi et profession) (1958)
- N° 138 sur l'âge minimum (1973)
- N° 182 sur les pires formes de travail des enfants (1999)

Par ailleurs, nous appliquons les exigences d'autres conventions internationales relatives à la gestion des forêts, telles que les conventions sur la **biodiversité**, le protocole de **Kyoto sur le réchauffement climatique** et la CITES.

ÉCOLOGIQUE ET DURABLE

CHALETS FORESTIERS

Cabins in the wood





CHALETS FORESTIERS

Cabins in the wood

Notre nouvelle gamme se concentre sur ceux qui veulent embrasser la nature et séjourner au cœur de la forêt et des bois avec un minimum de luxe pour profiter de la splendeur naturelle que Mère Nature nous offre. Ces constructions se distinguent par leur apparence simple et leur conception pragmatique. Vous avez la possibilité d'opter pour de grandes baies vitrées dans un design alternatif ou non. Le point de chute idéal pour les chasseurs, les amoureux de la nature et les ornithologues.

FENÊTRES TRIANGULAIRES



AVANTAGES

- Différentes alternatives de formes de toit, telles que la toiture simple pente (7 à 9°), la toiture asymétrique à 2 pentes (7 et 15°) toit et éventuellement toit de chalet (42 °)
- Revêtement de toit : principalement des panneaux à profil métallique, mais en cas de pente >15°, des bardeaux sont également possibles.
- Fenêtres/portes isolées de la gamme Premium ou fenêtres/portes en aluminium de la gamme Supreme
- Épaisseur du bois 45 ou 56 mm
- Fenêtres triangulaires Alu à placer au-dessus de la corniche

CHALETs FORESTIERS

NAVASSA

porte et fenêtres premium avec des volets en option

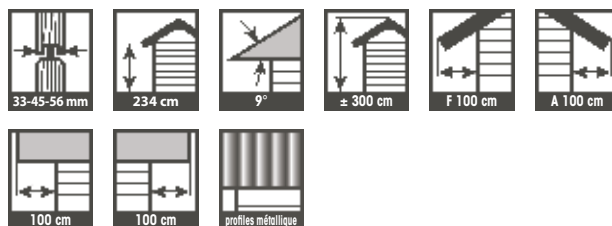
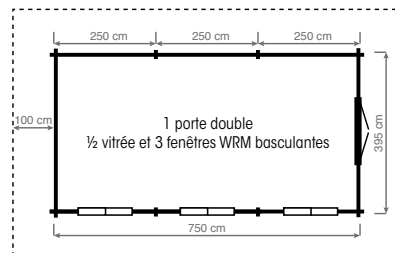

MONASTIR

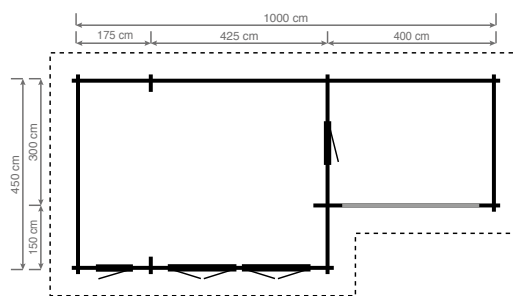

1 panneau de verre coulissant, 2 portes doubles WDD11, 1 porte plein Premium, 1 porte simple WDE34 et 1 fenêtre WRC



HULDRA

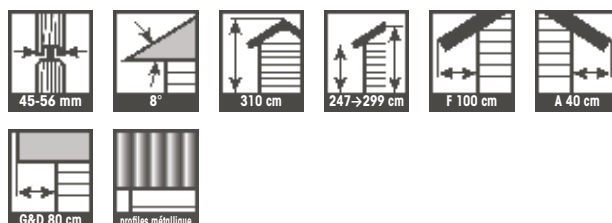
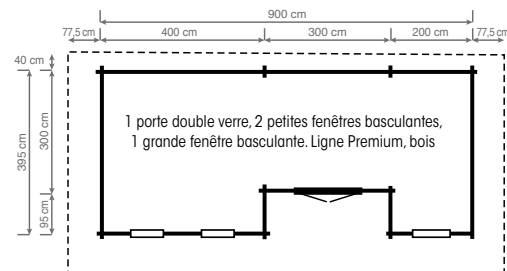

TIURI

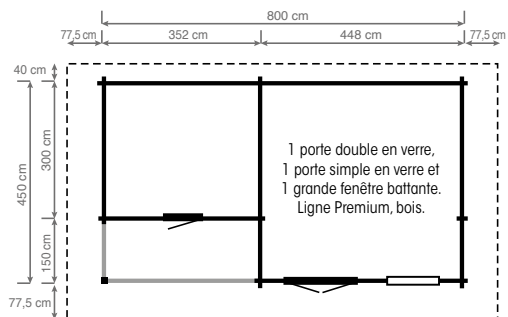

CHALETs FORESTIERS

PIAKI

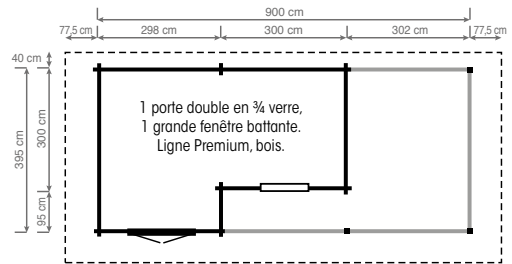

RISTRi

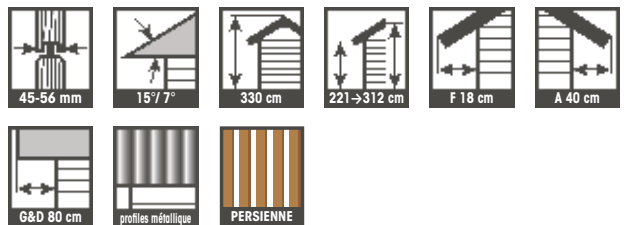
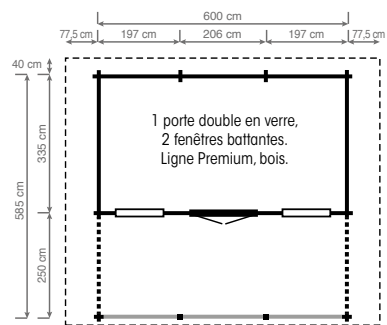

JOTUN

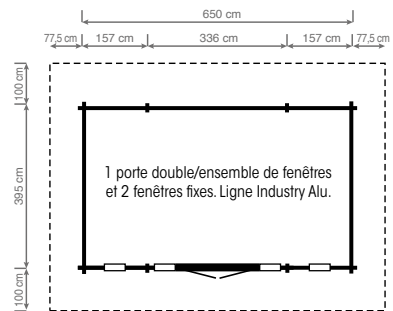

BRAGI

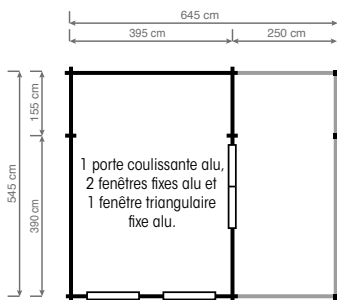

CHALETS FORESTIERS

GRYIA

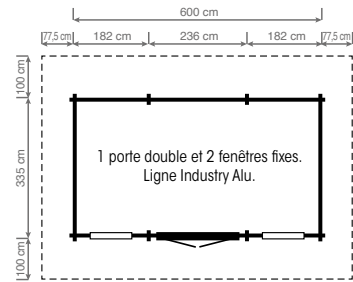

45-56 mm	17°	377 cm	234→338 cm	F 100 cm	A 100 cm
G&D 80 cm	profiles métallique				

SERKUR

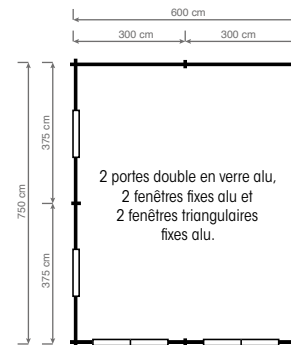

45-56 mm	15°	370 cm	286 cm	F 24 cm	A 24 cm
G&D 18 cm	shingles				



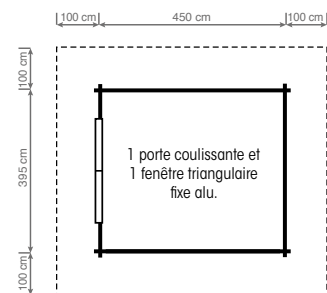



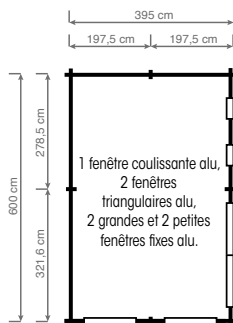

VIRIDI



45-56 mm	15°	422 cm	286→390 cm	F 100 cm	A 100 cm
G&D 100 cm	shingles				

PICARIO



 45-56 mm	 42°	 440 cm	 260 cm	 F 24 cm	 A 24 cm
 G&D 18 cm	 shingles	 ALUMINIUM SYSTEM PLUS			

INDUSTRY





INDUSTRY

Le style industriel, également appelé « Industrial chic », fait référence à une tendance en matière de design intérieur qui consiste à récupérer des éléments d'anciens bâtiments manufacturiers récemment convertis en lofts. Parmi les éléments de ce style, citons les matériaux authentiques (bois vieilli, etc.), des matériaux bruts, de grandes baies vitrées, des tons simples et rustiques (comme les tintes de gris), etc. Nous avons tenté de cristalliser une atmosphère d'entrepôt au sein de cette ligne de produits.

ALUMINIUM fenêtres/portes



AVANTAGES

- Gamme de fenêtres et portes industrielles dans un style de loft
- Épaisseur du bois 45 et 56 mm
- Vitrage isolant 4-16-4 HR+ ; valeur $U_g = 1,1 \text{ W/m}^2\text{K}$
- Fenêtres et portes à rupture de pont thermique
- Coloris anthracite des fenêtres / portes
- Toutes formes de toit possibles

INDUSTRY

JENSON

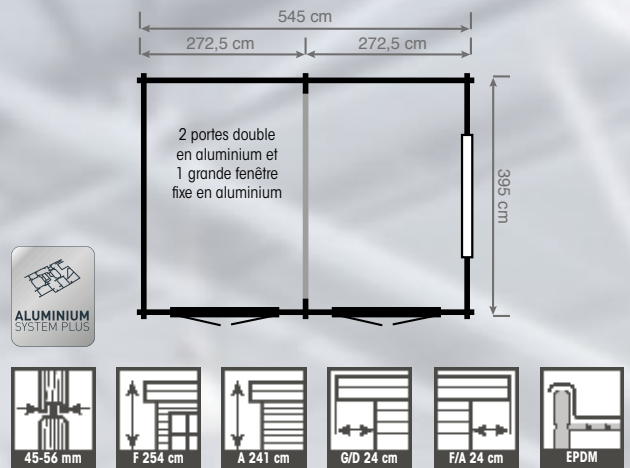

GIMSON

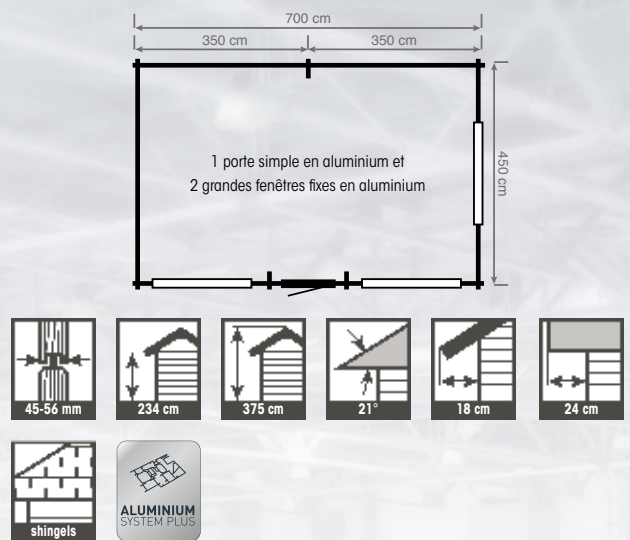

DRESSER

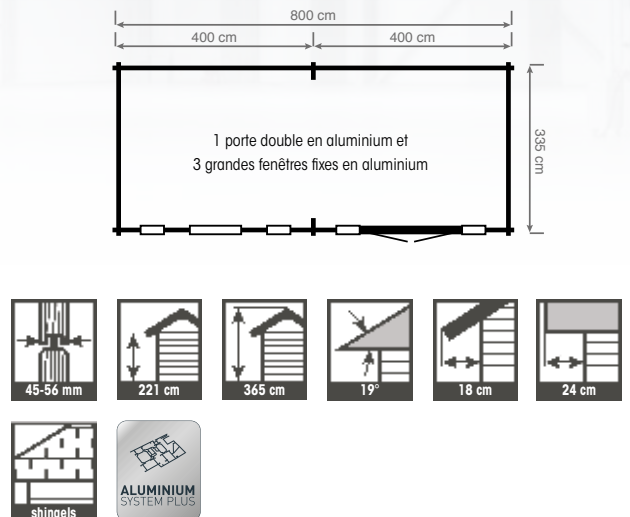

TUDOR

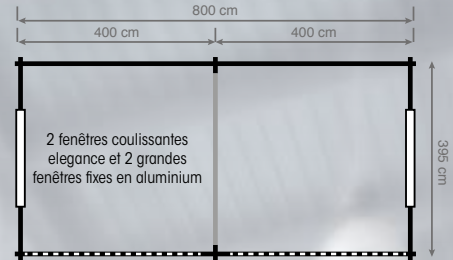

KELMOT

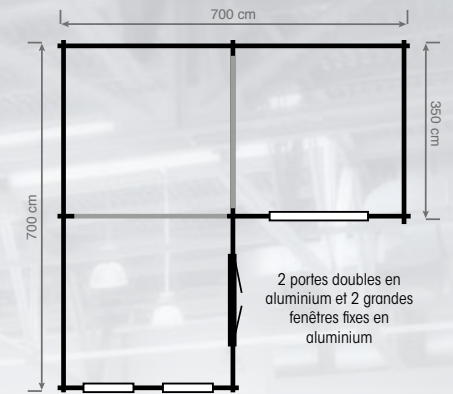

PRIOR

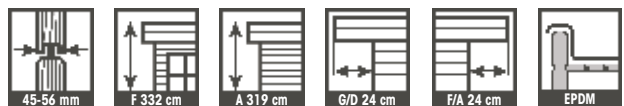
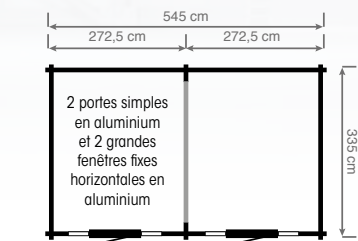

INDUSTRY

DAWSON

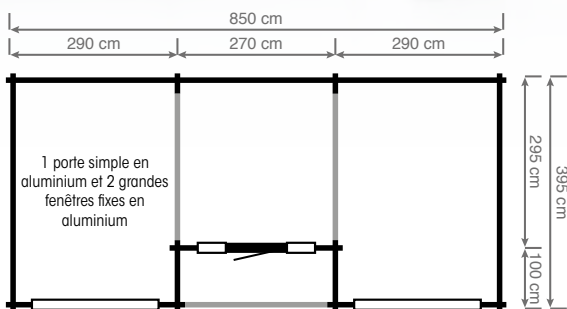

PEACOCK

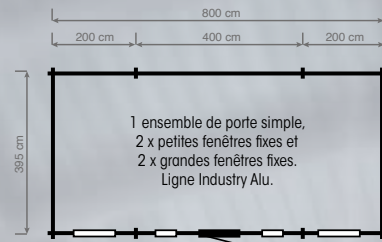

	PRINCIPAL 	PRINCIPAL 	DÉPENDANCE 		

GODMAN

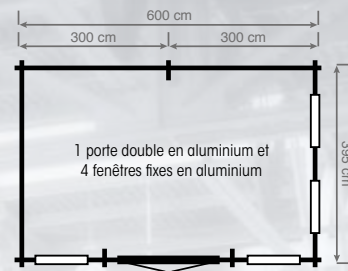

WALKER

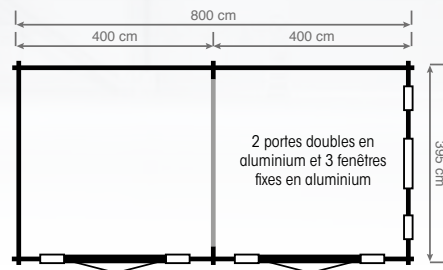

INDUSTRY

MENDINI

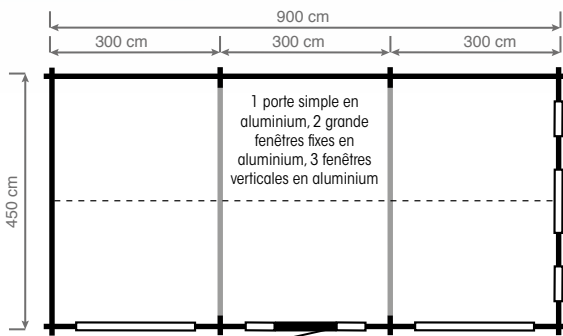

- 30° (Roof pitch)
- 375 cm (Internal height)
- 241 cm (Internal width)
- D/G 24 cm (Door/Glazing depth)
- F/A 18 cm (Front/Back depth)
- shingels (Roofing type)
- 45-56 mm (Floor thickness)
- ALUMINIUM SYSTEM PLUS (Material/Finish)

RUSKIN



MORRIS



RAM

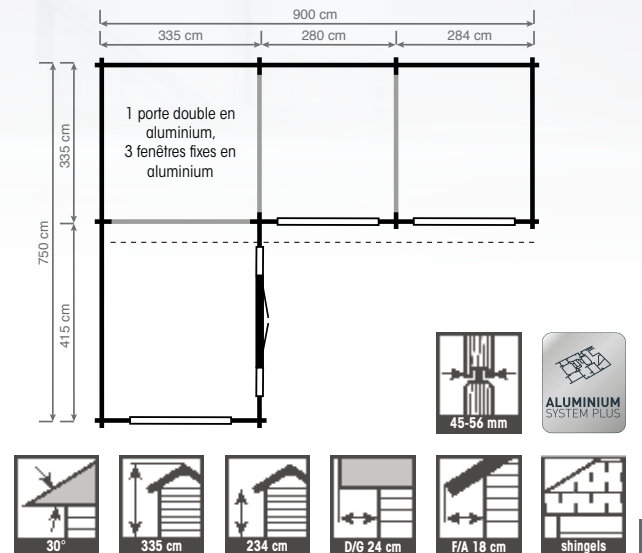

INDUSTRY

COLANI

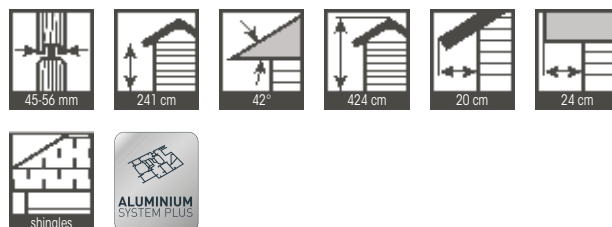
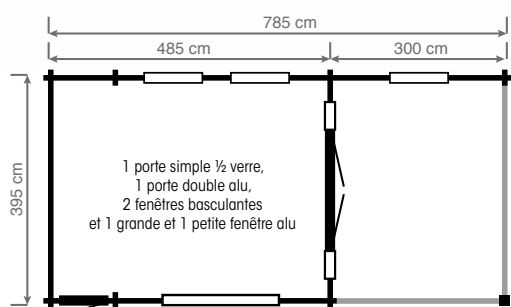

COUVERTURE DU TOIT PREMIUM

TOITURE PLATE

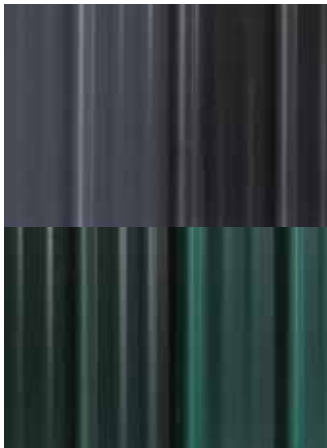

PANNEAUX PROFILÉS MÉTALLIQUES

- Panneaux métalliques massifs et galvanisés
- Revêtement en polyester-silicone 25 microns
- 4 coloris : anthracite, vert, vert foncé, gris

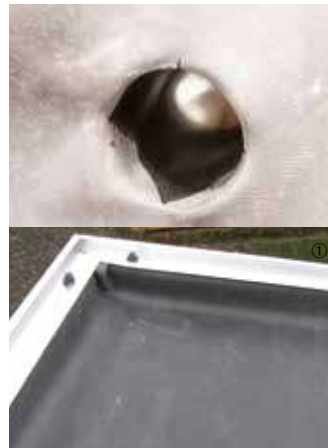

CAOUTCHOUC EPDM AVEC FINITION EN ALUMINIUM

- Caoutchouc EPDM 400% élastique
- Certifié ATG
- Résistant aux UV et à l'ozone
- Sans le moindre entretien et 100% recyclable
- Finition avec des profilés en aluminium élégants de 35 x 45 mm
- Angles prémontés
- Avaloir pour égouttage ①

TOITURE EN PENTE



PANNEAUX DE TUILE

- Acier de qualité suédoise
- Résistent au gel, à la chaleur, à la grêle et à la tempête
- Auto-nettoyants, pas de formation de mousse
- Disponibles en 5 couleurs : anthracite, noir, brun, terracotta et cloudy terracotta



ARDOISES OU CASSEROLES

- Pignon de toit/façade adapté
- Tous les types possibles
- Vue authentique



SHINGLES BITUMÉS

- Shingles en asphalte et tissu de verre
- 4 couleurs : noir, vert, brun, rouge
- Toiture standard



SHINGLES CAMBRIDGE

- Shingles double couche en asphalte et tissu de verre
- L'allure authentique des 'cottages' anglais
- Couleur : brun



CAMBRIDGE XTREME

- Bardeaux doubles autoadhésifs
- Couleur : Gris Harvard Slate
- Possible à partir de 9,5°

Caractéristiques spéciales

- Résistance plus impressionnante à la pluie dirigée par le vent
- Revêtement de toit résistant aux conditions météorologiques extrêmes

ABRIS DE SALON





ABRIS DE SALON

Le jardin se veut de plus en plus le prolongement de la pièce de vie. Rien de tel que de s'y reposer, y partager un repas, y faire du cocooning... Et de préférence dans un cadre agréable aménagé avec élégance et bon goût. Nos modèles de salons de jardin offrent à ce titre la solution idéale. Des pavillons modernes semi-ouverts parsemés de magnifiques persiennes en Thermowood qui ne demandent aucun entretien. Rêvez les yeux ouverts et laissez libre cours à votre fantaisie.

Persienne en Thermowood



AVANTAGES

- Toit plat finition EPDM et profils alu en inox
- Épaisseur du bois 45 ou 56 mm
- Persiennes en poutres Thermowood de 56 x 118 mm. Interstices de 56 mm
- En option : puits de lumière 80 x 200 cm en verre de sécurité en polycarbonate trempé
- En option : terrasse avec revêtement antidérapant 28 x 145 mm

ABRIS DE SALON

SOCO

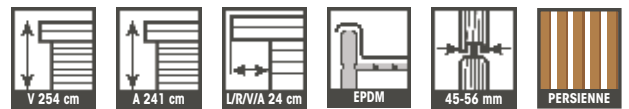
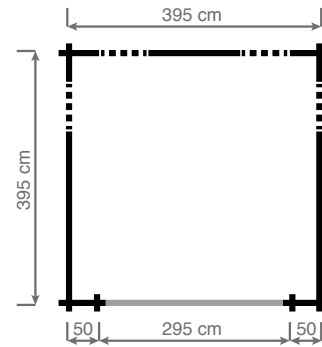

KLEIN

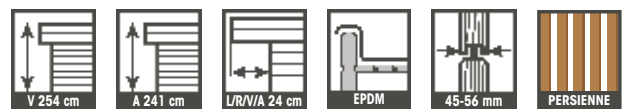
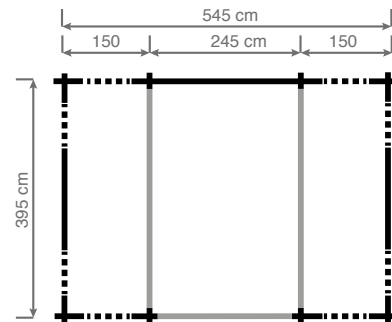

SHAPIRO

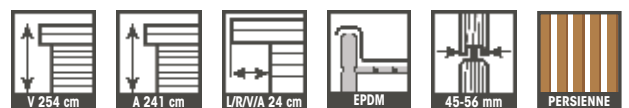
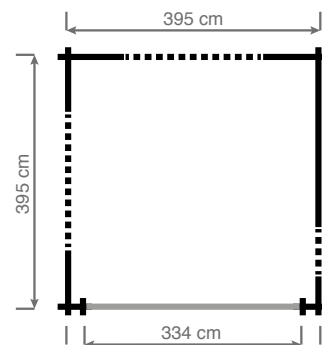

JUDE

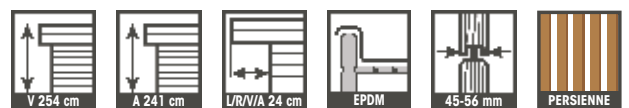
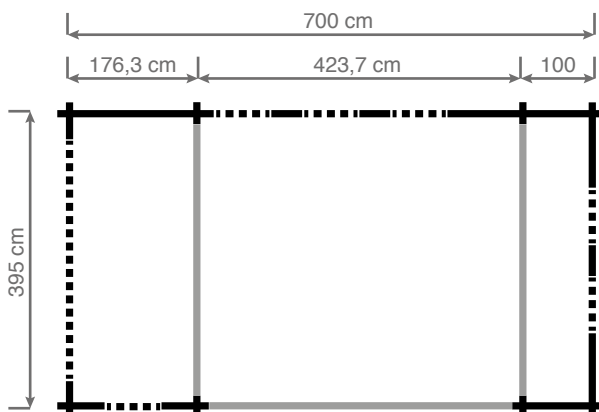

ABRIS DE SALON

CORSE

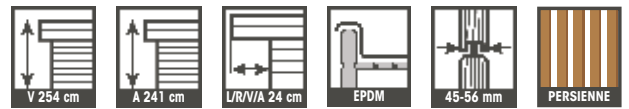
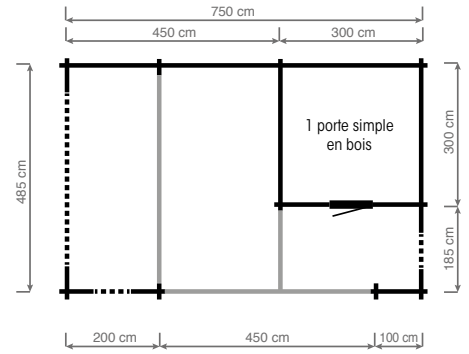

ULMAN

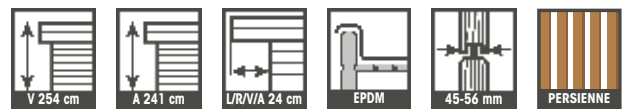
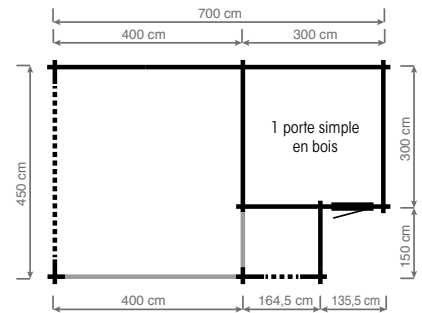



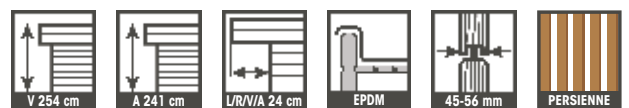
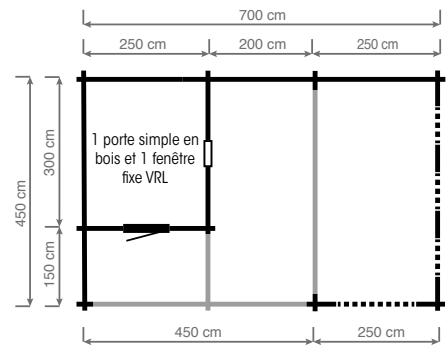

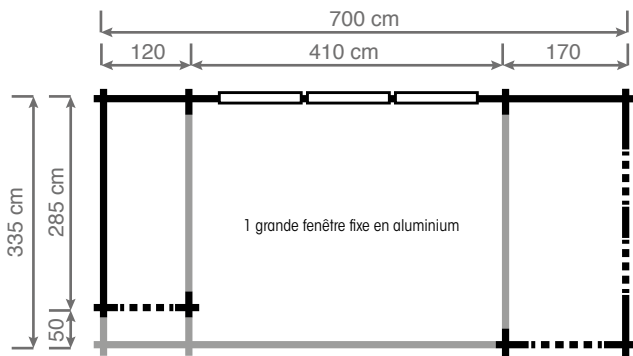

LONG



UFAN



- 
V 254 cm
- 
A 241 cm
- 
L/R/V/A 24 cm
- 
EPDM
- 
45-56 mm
- 
PERSIENNE

ABRIS DE SALON



SERRA

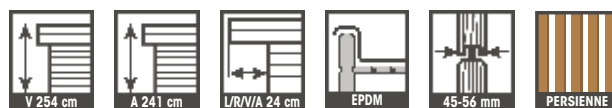
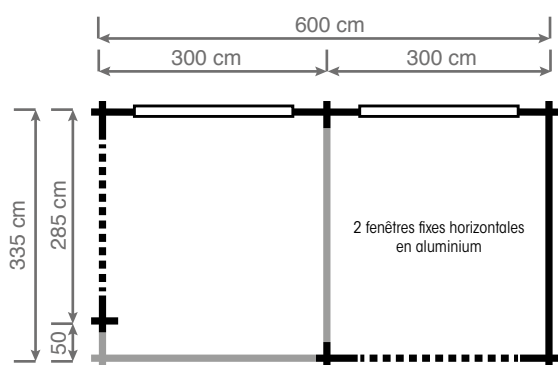



PRODUITS DE CHEZ NOUS



CERTIFICAT D'AUTHENTICITE



PEFC
PEFC/07-31-200



PRODUIT DE CHEZ NOUS



LE SPÉCIALISTE DU SUR MESURE

Par ce certificat on déclare que la construction Grandcasa, objet du bon de commande _____, est une production authentique de Top-Cottage, originaire du site de production à Elversele, Belgique, et également produit selon la norme de qualité Force Plus pour les profils en coupe-vent.

Ce certificat garantit également que la construction mentionnée ci-dessus est construite avec du bois qualitatif-pin, originaire du Nord de l'Europe, livrée conforme à la norme NEN(5466) avec le certificat KOMO correspondant et certifiée PEFC (CoC N° CTIB-TCHN 0938).

Elversele - Belgique, 2023

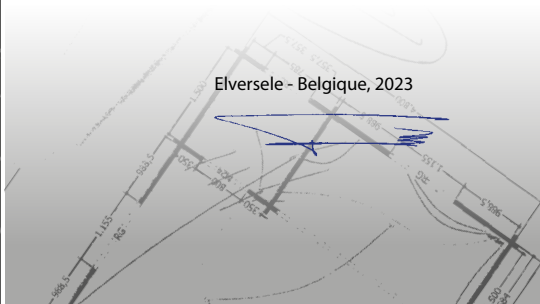

Emis par:
Pontweg 9C - 9140 Elversele - tél: +32 (0)52 460 111
info@top-cottage.com

www.top-cottage.com

CERTIFICAT D'AUTHENTICITÉ = CERTIFICAT D'ORIGINE

Un certificat d'authenticité est en réalité un certificat d'origine. De cette manière, nous vous garantissons que votre chalet Grandcasa est un produit d'origine qui provient de nos manufactures et a été produit dans les pays du Benelux selon le principe des profilés de chalet coupe-vent, notre label de qualité Force Plus.

Ce label de qualité garantit également l'origine et la qualité du bois. Les chalets de la marque Grandcasa sont aussi certifiés PEFC.

Le certificat d'origine de nos chalets vous garantit que votre chalet a été produit en suivant un processus de production de qualité conforme aux normes occidentales avec du bois de qualité, cultivé dans le respect de l'environnement. Nous avons développé ce certificat d'authenticité parce qu'il existe sur le marché des produits bien meilleur marché, mais de qualité moindre, fabriqués en Europe centrale et/ou de l'Est selon un processus de fabrication douteuse et avec du bois de moins bonne qualité. Souvent, la vraie qualité du produit est passée sous silence, mais le client apprend tôt ou tard les conséquences désastreuses de son choix. Nous vous conseillons donc d'acheter un chalet avec un certificat d'origine. Au final, vous ferez des économies. Méfiez-vous des copies bon marché provenant d'Europe de l'Est.

DEMANDEZ TOUJOURS VOTRE CERTIFICAT D'AUTHENTICITÉ!

Faites attention aux constructions inférieures de l'Europe de l'Est

SERVICE ET GARANTIE

Notre service après-vente est disponible 6 jours sur 7, du matin au soir. Nos services production et service après-vente se situent en Belgique, à proximité de nos clients ! C'est pourquoi nous vous offrons une garantie de 10 ans sur les défauts de production et/ou de fabrication.



PROFIL IMPERMÉABLE AU VENT

- Double fraisage
- Les plus grandes rainures et languettes du marché. 15 mm assure une plus grande robustesse



DU BOIS DE QUALITÉ

Les chalets Grandcasa sont fabriqués avec du pin de qualité provenant d'Europe du Nord, selon les normes NEN 5466, et ils sont livrés avec un certificat KOMO. Le froid fait pousser ces arbres plus lentement, ce qui rend le bois plus solide et permet de garantir une durée de vie sensiblement plus longue à nos chalets.



TAKAHIKUI





TAKAI-HIKUI

Combiner le meilleur de tous les mondes sans perdre l'équilibre et la beauté de quelque chose qui est simplement bien conçu. Dans la ligne Takai-Hikui, nous jouons avec une combinaison de différentes hauteurs et plaines, tout comme l'ancien concept des jardins japonais.

L'objectif n'est pas de vous faire voir l'ensemble de la conception d'un seul coup d'œil. Découvrez la combinaison de niveaux, de formes et de lignes qui s'enchaînent harmonieusement. Une construction Takai-Hikui est un lieu de retraite, presque une forme de méditation et de contemplation.



AVANTAGES

- Plusieurs formes de toit possibles ou une combinaison de différentes formes de toit possibles
- Épaisseur du bois 33, 45 et 56 mm
- Vaste assortiment de fenêtres et portes, toujours équipées de verre authentique
- Persiennes en poutres Thermowood de 56 x 118 mm
- En option : puit de lumière 80 x 200 cm en verre de sécurité en polycarbonate trempé

TAKAHIKUI

KENZO

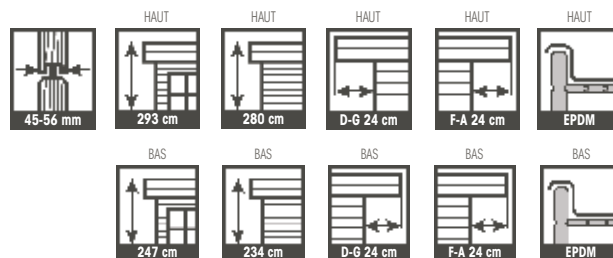
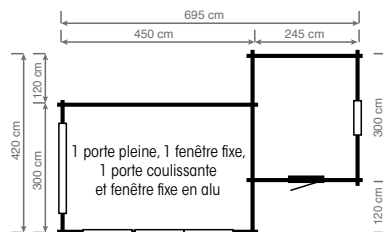

KIMI

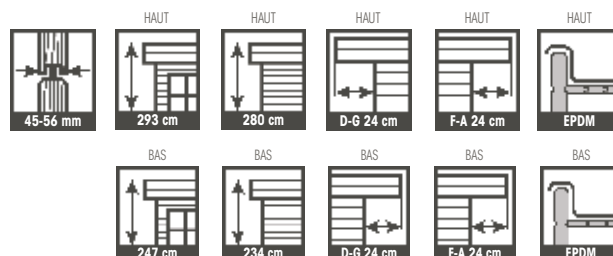
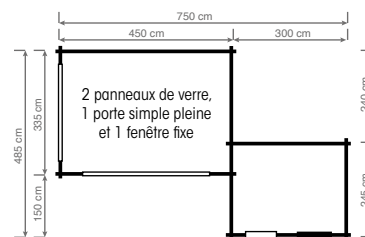

MIKI

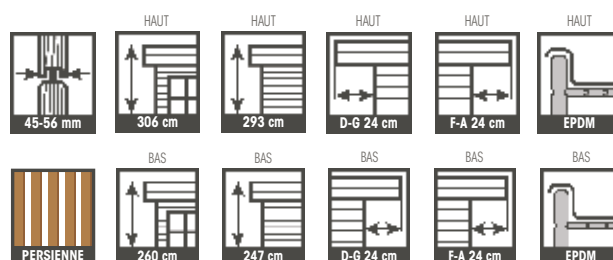
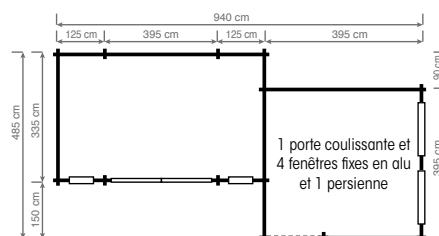

YURI

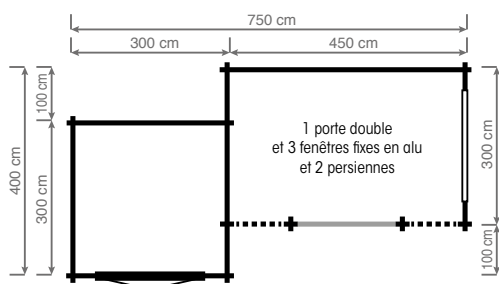

	HAUT 45-56 mm	HAUT 345 cm	HAUT 332 cm	HAUT D-G 24 cm	HAUT F-A 24 cm	HAUT EPDM
	PERSIENNE	BAS 260 cm	BAS 247 cm	BAS D-G 24 cm	BAS F-A 24 cm	BAS EPDM

AMAYA

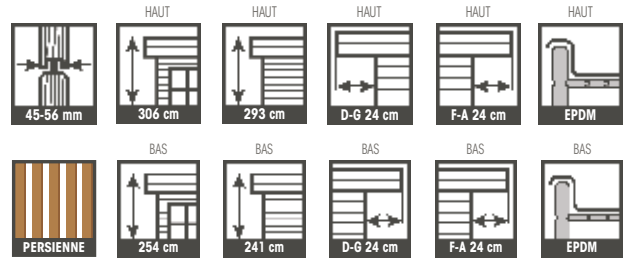
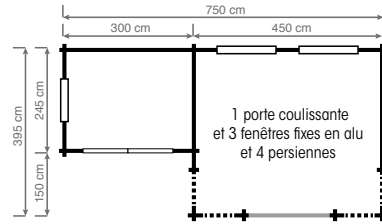

EMI

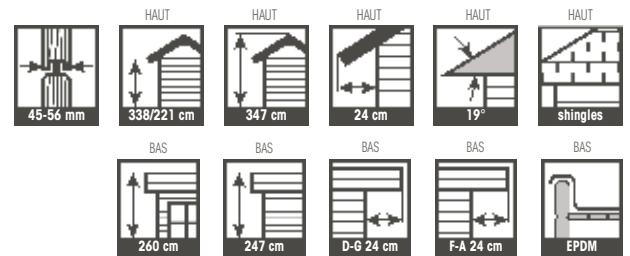
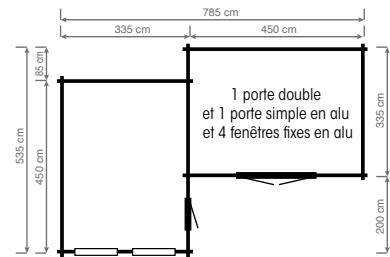

AKIRA

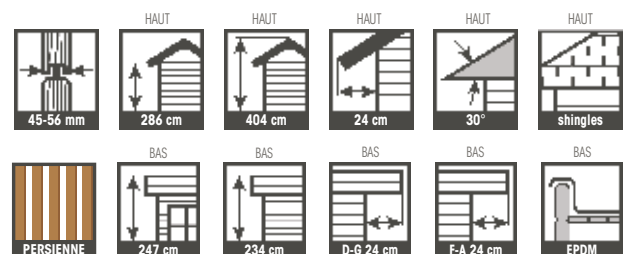
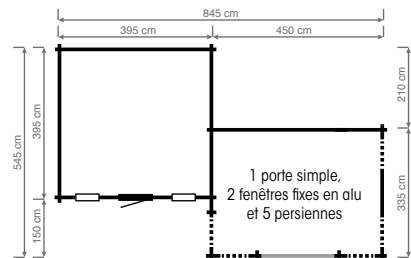



UN TRAVAIL SUR MESURE EN 3 ÉTAPES

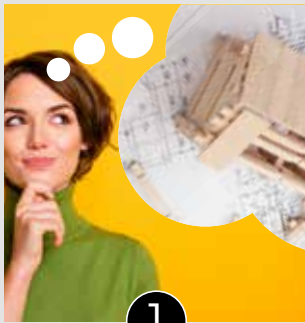

1
VOTRE IDÉE

Tout commence avec votre idée de la construction de vos rêves. Notre catalogue peut vous aider à trouver l'inspiration. Vous pouvez faire quelques dessins et/ou croquis.



2
CONTACTEZ LE POINT DE VENTE LE PLUS PROCHE

Prenez contact avec le point de vente de votre région. Vous pouvez nous rendre visite pendant les heures d'ouverture ou prendre rendez-vous avec un de nos conseillers.



3
VOTRE DEVIS PERSONNALISÉ

Notre expert traduira vos souhaits de façon technique et évaluera la faisabilité de votre projet. Sur la base de cet entretien, il vous remettra un devis personnalisé du projet de vos rêves.

DU SUR-MESURE À DES PRIX STANDARDS

- ✓ UN CERTIFICAT D'AUTHENTICITÉ
- ✓ AUCUN PRODUIT VIENT D'EUROPE DE L'EST, C'EST GARANTI
- ✓ UNE GARANTIE DE 10 ANS SUR LES DÉFAUTS DE PRODUCTION ET/OU DE FABRICATION

WELLNESS SAUNA





WELLNESS SAUNA

Détendez-vous ! Notre gamme de saunas modernes et de qualité qui est un vrai délice pour le corps et l'esprit. Tous les éléments indispensables au sauna sont fabriqués en aulne, une essence européenne d'excellente qualité. L'aulne possède une longue durée de vie que la présence d'eau et d'humidité allonge encore. Les bâtiments historiques reposent souvent sur des pieux en aulne. Grâce aux propriétés exceptionnelles de ce matériau, vous profiterez de moments de détente dans votre sauna conçu sur mesure durant de nombreuses années.

AVANTAGES

- Parois de 56 mm d'épaisseur, une épaisseur de 45 mm est également possible
- Convient comme sauna intérieur ou extérieur
- Porte design en verre de sécurité (8 mm) avec poignée et encadrement en aulne (69 x 192 cm)
- Doté de 2 éléments d'aération, dont un coulissant



Bois d'aulne : doux, résistant et fort.
Plus fort que le cèdre



WELLNESS SAUNA

EGER

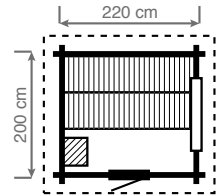

1 porte sauna et 1 fenêtre horizontale



OBUDA

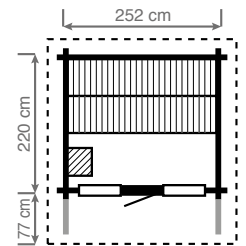

1 porte sauna et 2 fenêtres verticales

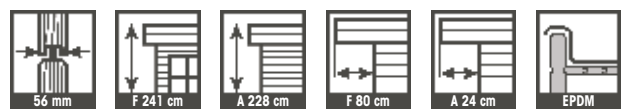

SOBOTA

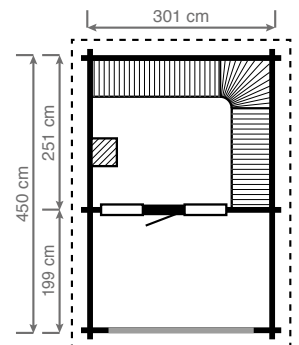
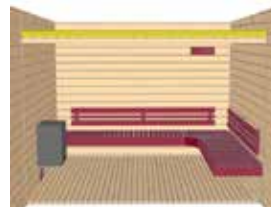

1 panneau de verre coulissant,
1 porte sauna et 2 fenêtres sauna verticales



ZALAKA

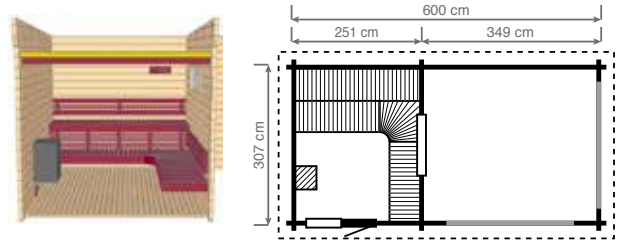

2 panneaux de verre coulissants, 1 porte sauna et 1 fenêtre sauna horizontale



HARKANY

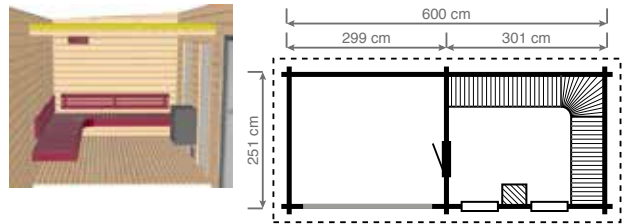

1 panneau de verre coulissant, 1 porte sauna et 2 fenêtres sauna verticales



SAVAR

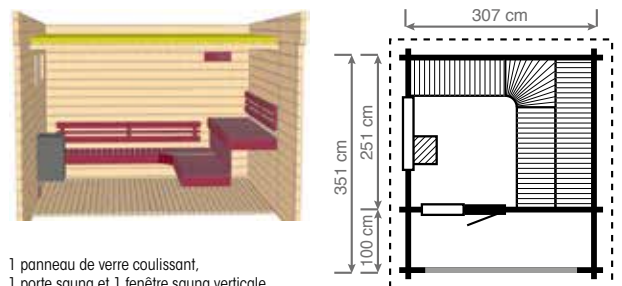

1 panneau de verre coulissant,
1 porte sauna et 1 fenêtre sauna verticale
et 1 horizontale



WELLNESS SAUNA

VILLANY

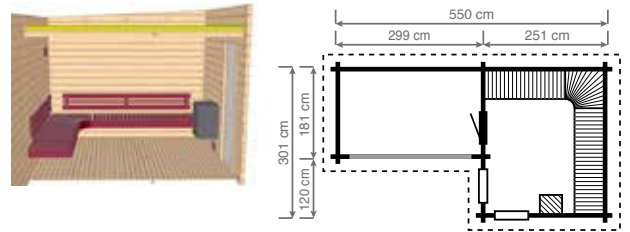

1 panneau de verre coulissant, 1 porte sauna et 2 fenêtres sauna verticales

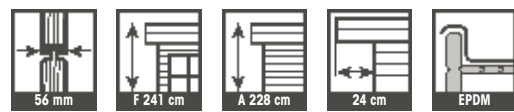

TAMBURA

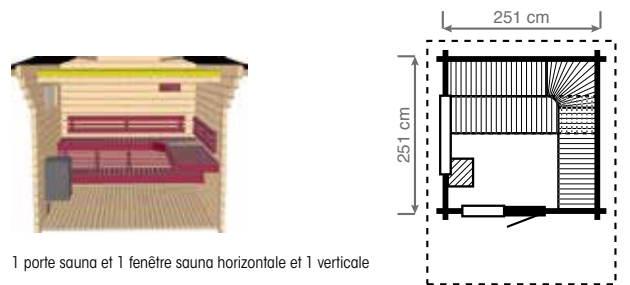

1 porte sauna et 1 fenêtre sauna horizontale et 1 verticale

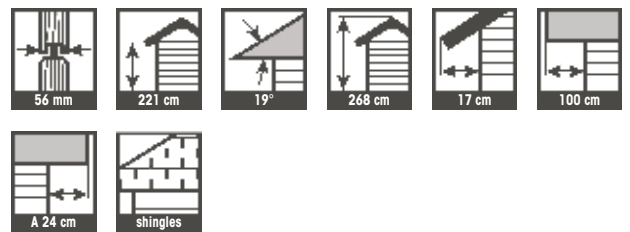

MOHAC

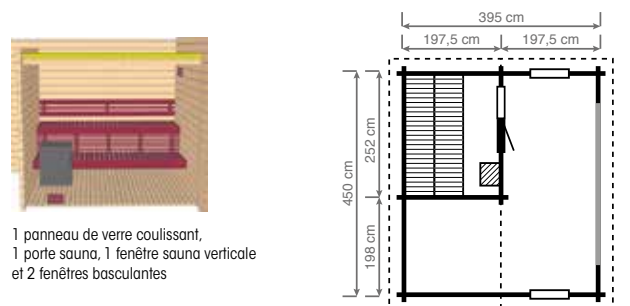

1 panneau de verre coulissant, 1 porte sauna, 1 fenêtre sauna verticale et 2 fenêtres basculantes

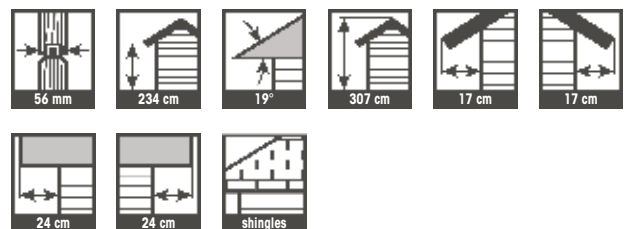

ACCESSOIRES EN POÊLES

ÉCLAIRAGE



EXTRAITS AROMATIQUES



INTÉRIEUR SAUNA



BANC
14 x 60 x 160-210-240 cm



DOSSIER
2,8 x 30 x 235 cm



THERMO- ET HYGROMÈTRE



SABLIER



APPUIE-TÊTE



GRILLE D'AÉRATION



PORTES ET FENÊTRES DE SAUNA

PORTE

- 69 x 192 cm
- verre de sécurité bronze de 8 mm
- encadrement et poignée en aulne avec serrure à rouleau intégrée



FENÊTRE VERTICALE

- 69 x 192 cm
- verre de sécurité bronze de 8 mm avec de l'aulne



FENÊTRE HORIZONTALE

- 120 x 40 cm
- verre de sécurité bronze de 8 mm avec de l'aulne

PIERRES POUR SAUNAS



20 KG

SEAU ET LOUCHE EN MÉTAL



CHAMPAGNE



GRIS



GOUDRON

TYLÖ-HELO VIENNA

- Poêle de sauna classique de qualité avec panneau de commande intégré à la base, temps de fonctionnement de 3 heures.
- Ce poêle est programmable jusqu'à 9 heures à l'avance.
- Puissance de 6,6 ou 8 kW.
- Le poêle peut uniquement être fixé au mur.
- **Unique** à raccorder sur du 1 x 240 V, 3 x 240 V ou 400 V + N.



100%
FABRICATION
ET DESIGN
SUÉDOIS



TYLÖ SPORT

- Mêmes fonctionnalités que le Tylö-Helo Vienna
- Protection contre les contacts, ne chauffe pas, sécurité enfants
- Protection extérieure Thermosafe
- Modèle mural ou à poser (avec pieds)

SHE SHED





SHE SHED

Les hommes doivent avoir leur espace, mais les femmes aussi. De nombreuses femmes très occupées ont besoin d'un endroit pour se reposer ou s'adonner aux activités créatives. Les femmes méritent certainement leur propre zone de confort et pourquoi pas en sirotant un gin tonic. Un bon nombre de pièces de vie sont des petits havres de paix. Aménagés avec de sympathiques fauteuils et peints dans des tons apaisants, ils offrent beaucoup de lumière naturelle et sont entourés de verdure. Laissez-vous inspirer par nos pièces de vie sur mesure.

AVANTAGES

- Plusieurs formes de toit possibles
- Épaisseur du bois 33,45 et 56 mm
- Poteau décoratif Athéna 14 x 14 cm en silhouette
- Puit de lumière 80 x 200 cm en verre de sécurité en polycarbonate trempé, haute résolution du bruit (-39 db)



Poteau
décoratif
Athéna
14 x 14 cm



OPTION: puit de lumière



SHE SHED

BÉATRICE

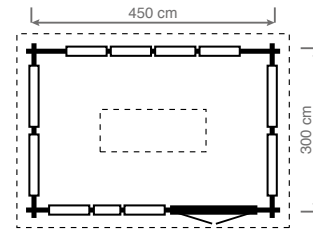

1 porte double ¾ vitrée, 4 fenêtres VRGL, 6 fenêtres VRLX fixe,
3 fenêtres VRL fixe et 1 puit de lumière

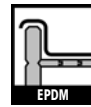

CAMILLA

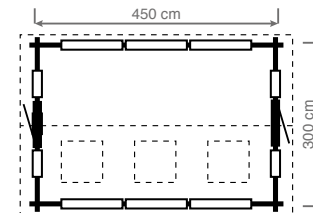

2 portes simples ¾ vitrée, 6 fenêtres VRGL, 4 fenêtres VRL fixe,
1 fenêtre VRS, 3 fenêtres de toit WRD

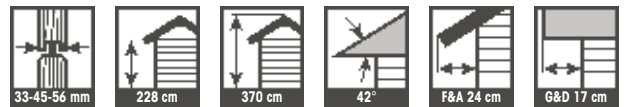

DIANA

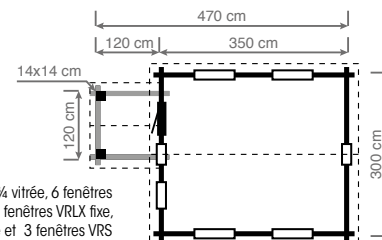

1 porte simple ¾ vitrée, 6 fenêtres VRGL, 4 fenêtres VRLX fixe,
1 fenêtre VRL fixe et 3 fenêtres VRS

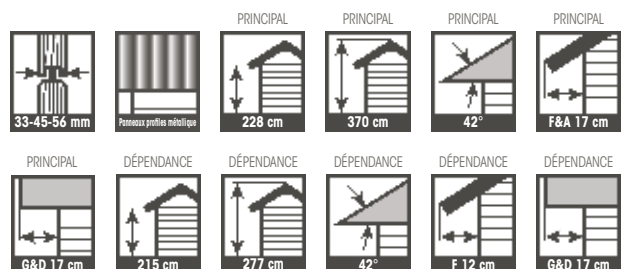

VICTORIA

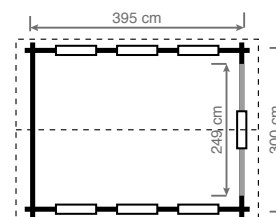

6 fenêtres fixe VRLX et 1 fenêtre ovale fixe VRO

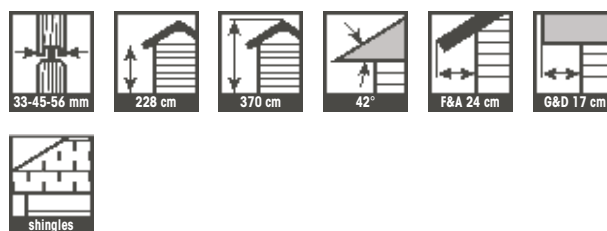

LOUIZA

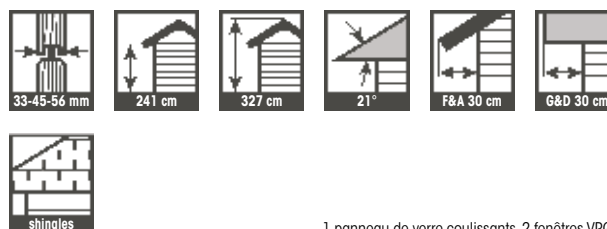
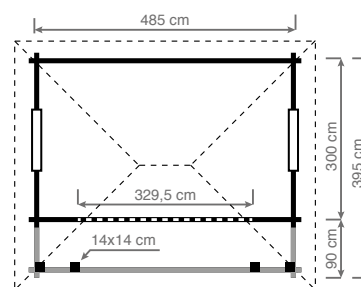

1 panneau de verre coulissants, 2 fenêtres VRGL

PAULINE

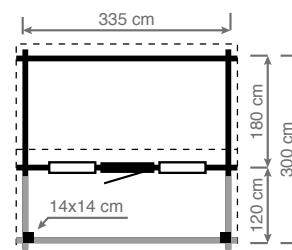

1 porte simple ¼ vitrée,
2 fenêtres VRLX fixe

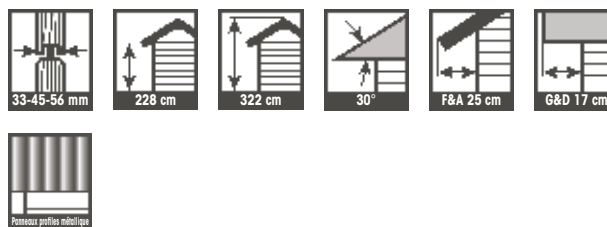

SHE SHED

KATARINA

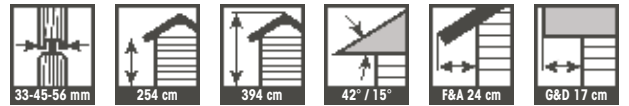
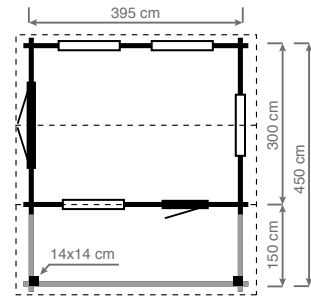

1 porte double ¾ vitrée, 1 porte simple ¾ vitrée,
4 fenêtres VRGL et 1 fenêtre ovale VRO fixe

FADIVA

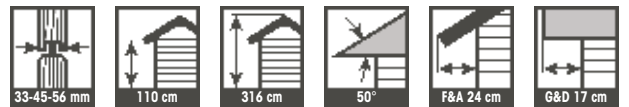
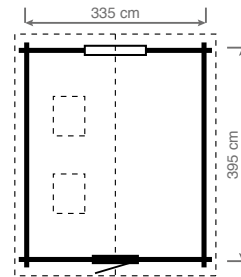

1 porte simple ¾ vitrée, 1 fenêtre VRGL,
4 fenêtres VRLX fixe, 2 fenêtres de toit WRD

JOSEPHINE

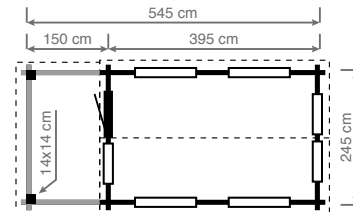

1 porte simple ¾ vitrée,
4 fenêtres VRGL, 3
fenêtres VRLX fixe
et 1 fenêtre ovale
VRO fixe

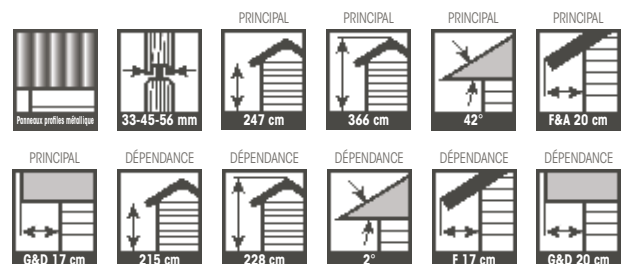



UN TRAVAIL SUR MESURE EN 3 ÉTAPES



1

VOTRE IDÉE

Tout commence avec votre idée de la construction de vos rêves. Notre catalogue peut vous aider à trouver l'inspiration. Vous pouvez faire quelques dessins et/ou croquis.



2

CONTACTEZ LE POINT DE VENTE LE PLUS PROCHE

Prenez contact avec le point de vente de votre région. Vous pouvez nous rendre visite pendant les heures d'ouverture ou prendre rendez-vous avec un de nos conseillers.



3

VOTRE DEVIS PERSONNALISÉ

Notre expert traduira vos souhaits de façon technique et évaluera la faisabilité de votre projet. Sur la base de cet entretien, il vous remettra un devis personnalisé du projet de vos rêves.

**DU SUR-MESURE À
DES PRIX STANDARDS**

- ✓ UN CERTIFICAT D'AUTHENTICITÉ
- ✓ AUCUN PRODUIT VIENT D'EUROPE DE L'EST, C'EST GARANTI
- ✓ UNE GARANTIE DE 10 ANS SUR LES DÉFAUTS DE PRODUCTION ET/OU DE FABRICATION

STYLE RURAL





STYLE RURAL

Un brin de nostalgie. Tout le monde se souvient des westerns avec leurs petits hameaux typiques et leurs villages de chercheurs d'or. C'est dans ce cadre que nous avons puisé l'inspiration pour notre gamme Farm. Caractéristique du genre, les portes à double battant et les portes et fenêtres protégées par des volets aussi robustes qu'esthétiques. Une gamme nostalgique et originale qui vient prendre à contrepied les constructions souvent très modernes. La dure vie au grand air, un retour à la nature.

Grandes portes à double battant



AVANTAGES

- grandes portes à double battant de 114,5 cm x 202 cm
- vaste choix de revêtements de toit: bardeaux, panneaux de tuiles, panneaux profilés métalliques
- épaisseur du bois 45 ou 56 mm
- portes et fenêtres haut de gamme avec volets fonctionnels

STYLE RURAL

DIPRO

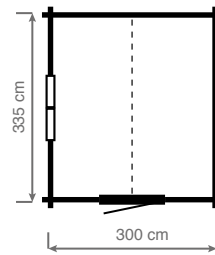

1 porte stable WPD,
1 fenêtre WRG + volets

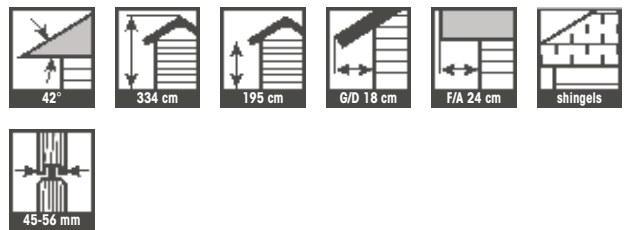

TINGA

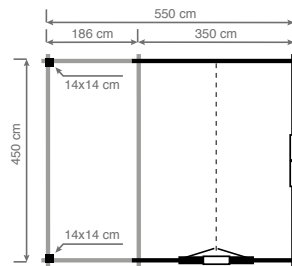

1 porte double ½ verre et
1 fenêtre WRG avec volets
+ 1 fenêtre ovale VRO

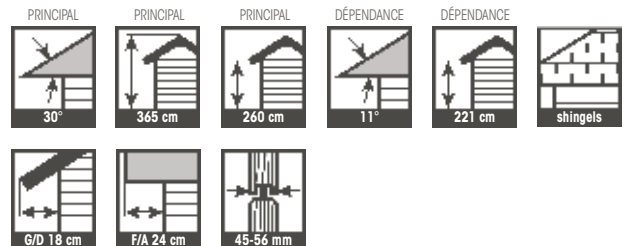

FUKONYS

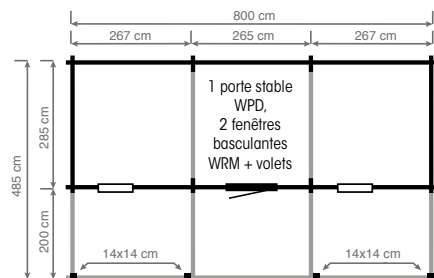

1 porte stable
WPD,
2 fenêtres
basculantes
WRM + volets

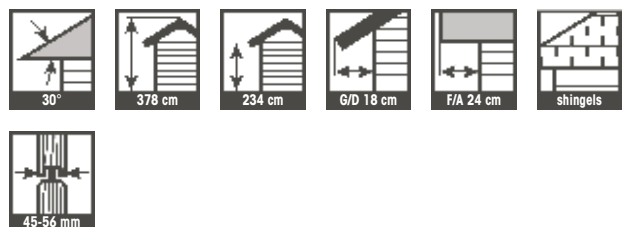

PILOSA

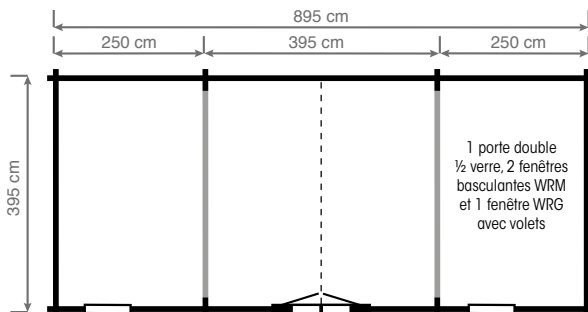

PRINCIPAL	PRINCIPAL	PRINCIPAL	DÉPENDANCE	DÉPENDANCE	shingels	G/D 24 cm	F/A 18 cm	45-56 mm
30°	443 cm	325 cm	15°	208 cm				

STYLE RURAL



PROCO

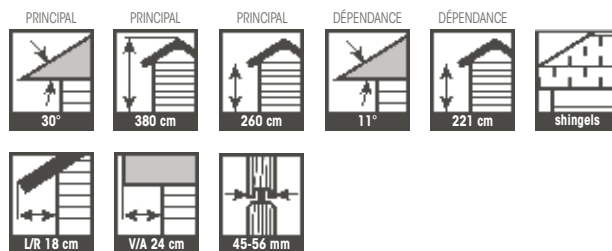
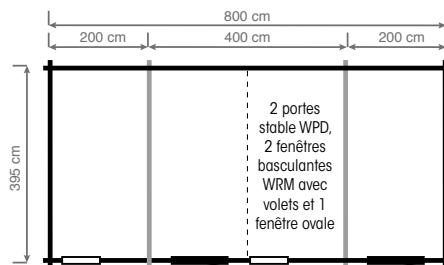

CREDONA

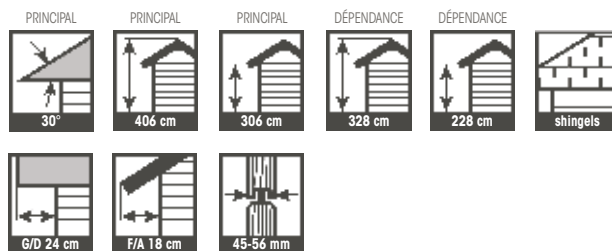
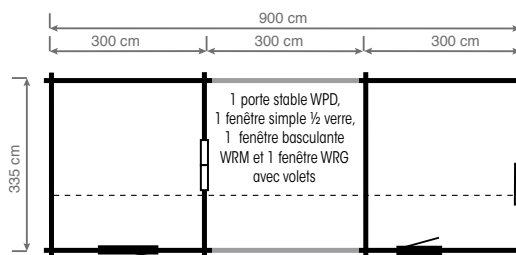

HARAMI

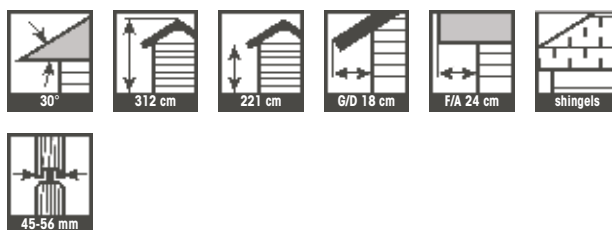
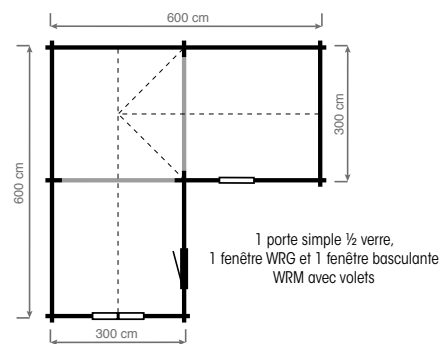



PRODUITS DE CHEZ NOUS



CERTIFICAT D'AUTHENTICITE



PRODUIT DE CHEZ NOUS



Par ce certificat on déclare que la construction Grandcasa, objet du bon de commande _____, est une production authentique de Top-Cottage, originaire du site de production à Elversele, Belgique, et également produit selon la norme de qualité Force Plus pour les profils en coupe-vent.

Ce certificat garantit également que la construction mentionnée ci-dessus est construite avec du bois qualitatif-pin, originaire du Nord de l'Europe, livrée conforme à la norme NEN(5466) avec le certificat KOMO correspondant et certifiée PEFC (CoC N° CTIB-TCHN 0938).

Elversele - Belgique, 2023

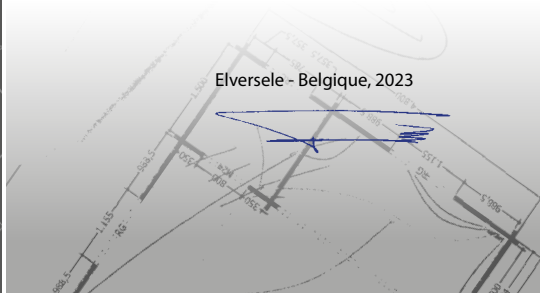

Emis par:
Pontweg 9C - 9140 Elversele - tél: +32 (0)52 460 111
info@top-cottage.com

www.top-cottage.com

CERTIFICAT D'AUTHENTICITÉ = certificat d'origine

Un certificat d'authenticité est en réalité un certificat d'origine. De cette manière, nous vous garantissons que votre chalet Grandcasa est un produit d'origine qui provient de nos manufactures et a été produit dans les pays du Benelux selon le principe des profilés de chalet coupe-vent, notre label de qualité Force Plus.

Ce label de qualité garantit également l'origine et la qualité du bois. Les chalets de la marque Grandcasa sont aussi certifiés PEFC.

Le certificat d'origine de nos chalets vous garantit que votre chalet a été produit en suivant un processus de production de qualité conforme aux normes occidentales avec du bois de qualité, cultivé dans le respect de l'environnement. Nous avons développé ce certificat d'authenticité parce qu'il existe sur le marché des produits bien meilleur marché, mais de qualité moindre, fabriqués en Europe centrale et/ou de l'Est selon un processus de fabrication douteuse et avec du bois de moins bonne qualité. Souvent, la vraie qualité du produit est passée sous silence, mais le client apprend tôt ou tard les conséquences désastreuses de son choix. Nous vous conseillons donc d'acheter un chalet avec un certificat d'origine. Au final, vous ferez des économies. Méfiez-vous des copies bon marché provenant d'Europe de l'Est.

DEMANDEZ TOUJOURS VOTRE CERTIFICAT D'AUTHENTICITÉ! Faites attention aux constructions inférieures de l'Europe de l'Est

SERVICE ET GARANTIE

Notre service après-vente est disponible 6 jours sur 7, du matin au soir. Nos services production et service après-vente se situent en Belgique, à proximité de nos clients ! C'est pourquoi nous vous offrons une garantie de 10 ans sur les défauts de production et/ou de fabrication.



PROFIL IMPERMÉABLE AU VENT

- Double fraisage
- Les plus grandes rainures et languettes du marché. 15 mm assure une plus grande robustesse



DU BOIS DE QUALITÉ

Les chalets Grandcasa sont fabriqués avec du pin de qualité provenant d'Europe du Nord, selon les normes NEN 5466, et ils sont livrés avec un certificat KOMO. Le froid fait pousser ces arbres plus lentement, ce qui rend le bois plus solide et permet de garantir une durée de vie sensiblement plus longue à nos chalets.



COULEUR ET ENTRETIEN



SUPER PROTECT - 5L

- Produit de protection qui teint le bois sans cacher les veines.
- Protection contre les intempéries et le bleuissement
- Hydrofuge, protège contre les rayons UV
- Peu odorant, ne s'écaille pas



- | | | |
|----|-------------|---------|
| 1 | Chêne clair | RAL0200 |
| 2 | Chêne | RAL0101 |
| 3 | Châtaigne | RAL0300 |
| 4 | Chêne foncé | RAL0103 |
| 5 | Blanc opale | RAL9001 |
| 6 | Gris clair | RAL0005 |
| 7 | Gris pierre | RAL7030 |
| 8 | Gris beige | RAL1019 |
| 9 | Vert salé | RAL0039 |
| 10 | Brun noir | RAL8022 |



SUPER PRIMER* - 5L

- Produit de protection du bois incolore et à forte pénétration.
- Action préventive et curative. Idéal comme couche d'apprêt.
- Insecticide, fongicide et anti-bleu
- Sans odeur tenace. Convient pour l'intérieur et l'extérieur.



VERNIS PARQUET POLYVINE - 2,5L

- Emballage par litre
- Résiste à la chaleur et aux taches
- Protection contre les stries de chaussures
- Sec en quelques minutes, laver avec de l'eau
- 15-20 m²/litre



VIKING - 2,5L

- Enduit couvrant (68 % de matières solides)
- Résines alkydes avec de l'huile de lin
- RÉGULATEUR D'HUMIDITÉ et HYDROFUGE (peut être mis en évidence)
- Résistant aux UV
- Élastique et EXTRÊMEMENT DURABLE



INDUSTRIAL



AMAZONE

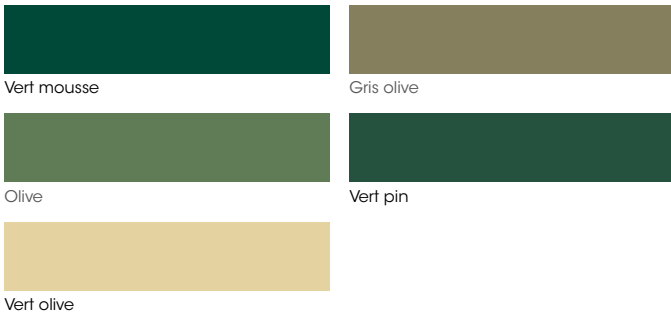

MARINE

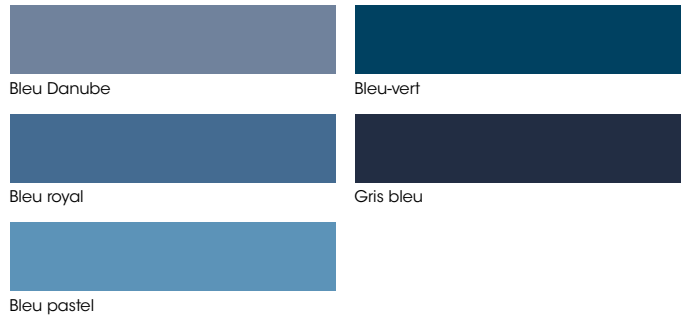

TERRA



ELEGANCE





ELEGANCE

Grâce à nos vitres coulissantes, vous créez en un tour de main un chalet de jardin, dont vous pourrez profiter toute l'année dans votre jardin ou sur votre terrasse.

Les panneaux de verre ne sont pas ceints d'un cadre, ce qui vous offre une vue complètement dégagée. En bref, vous vous sentez plus proche de la nature.

AVANTAGES

- Un toit plat, un toit royal ou un toit cottage
- L'épaisseur du bois est de 33, 45 et 56 mm
- De robustes poteaux de soutien de 14 x 14 cm
- Toiture : EPDM avec finition en aluminium ou shingles (tuiles en bois) disponible en quatre couleurs
- Vitres de 10 mm d'épaisseur en verre de sécurité
- En option : terrasse avec revêtement anti-dérapant 28 x 145 mm



OPTION: Puit de lumière 80 x 200 cm en verre de sécurité en polycarbonate trempé, haute résolution du bruit (-39 db)



ELEGANCE

BAJA

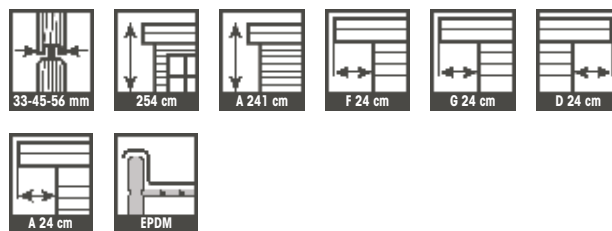
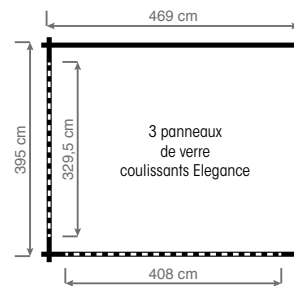

TATA

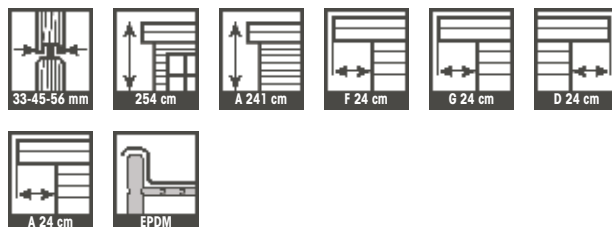
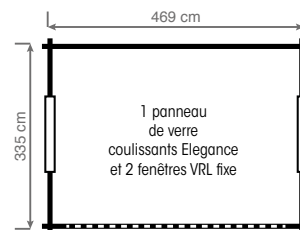

SIFY

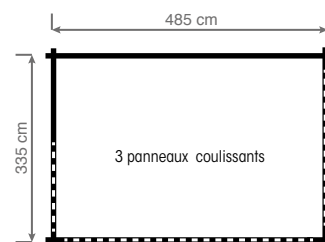

SILKO

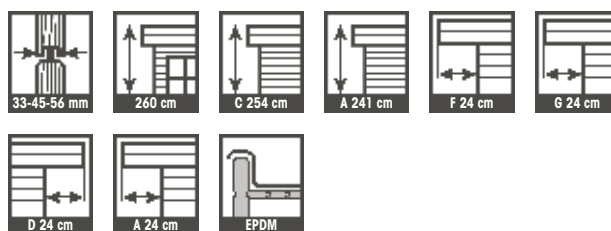
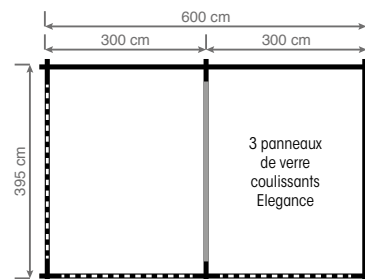

FARO

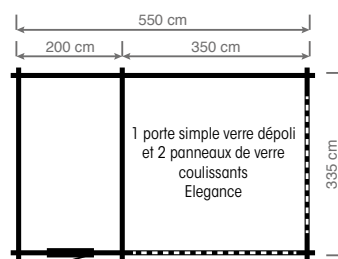

SINTRA

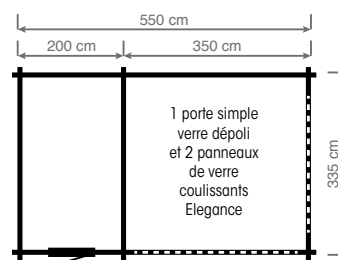

MORIENTES

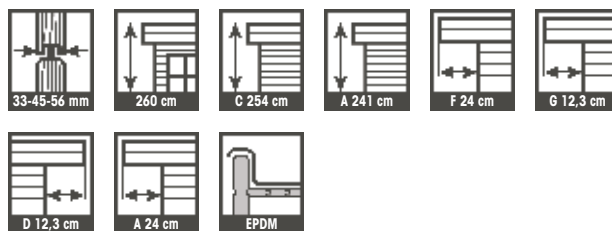
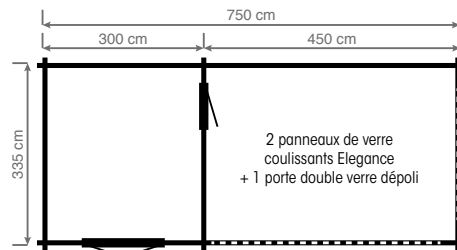

ESTORIL

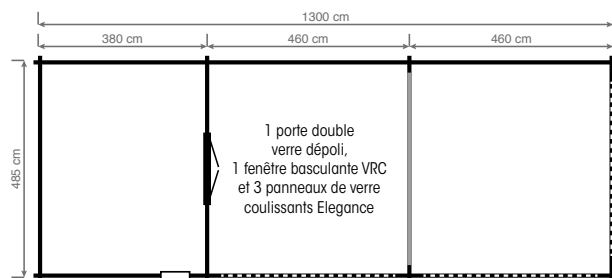

BENSON

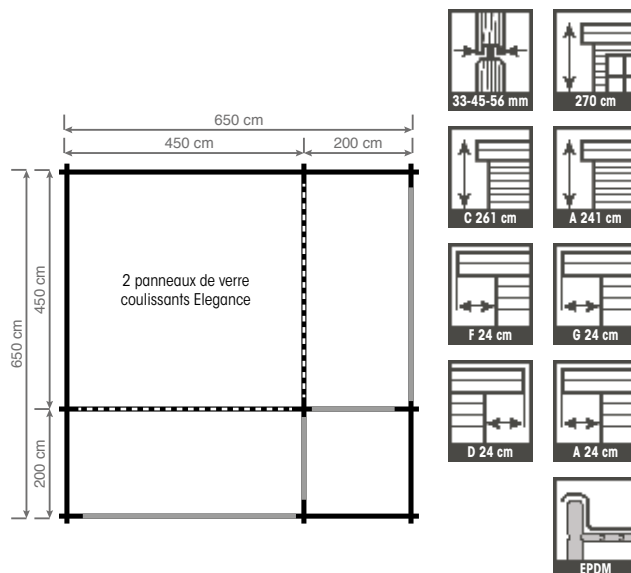

MILLET

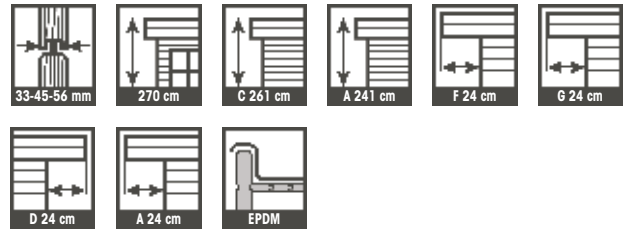
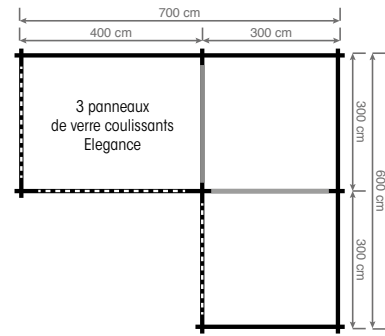

SOPRON

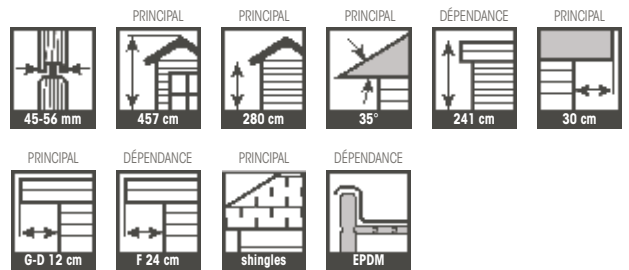
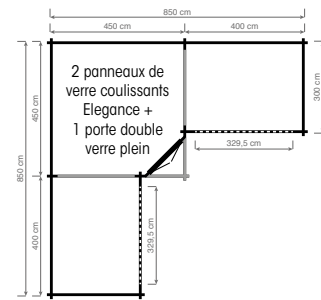

LAUTREC

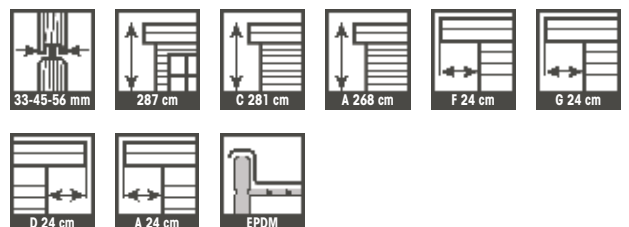
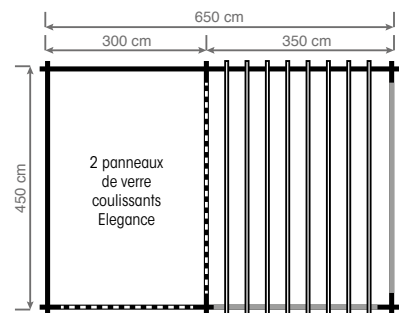

ELEGANCE

DABAS

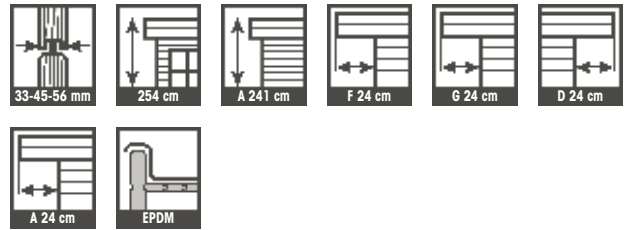
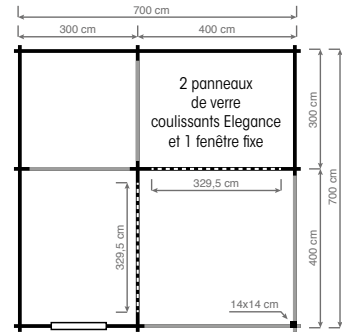

BALKANY

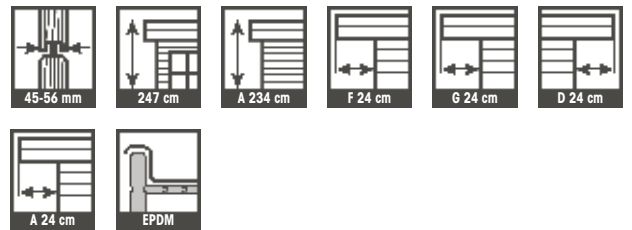
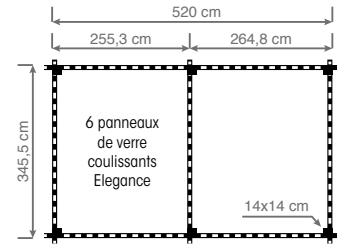

TIHANY

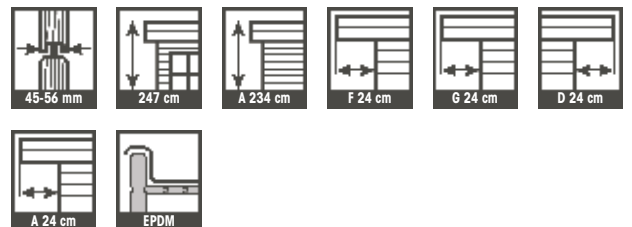
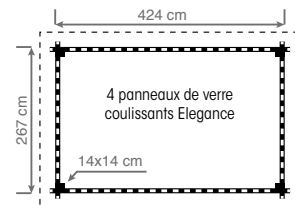

ESTEMOZ

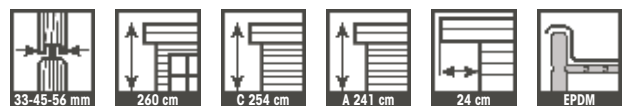
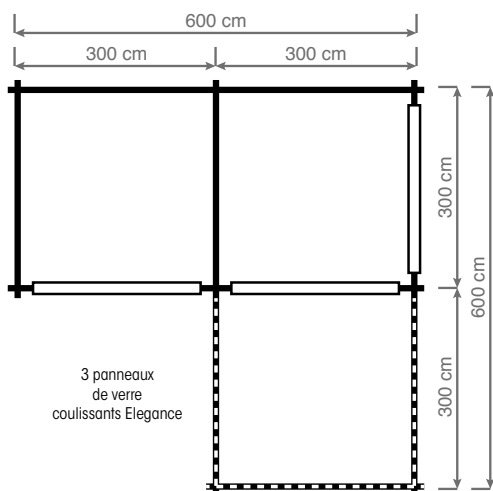

ELEGANCE

PICABIA

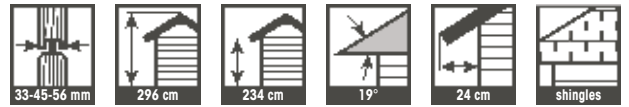
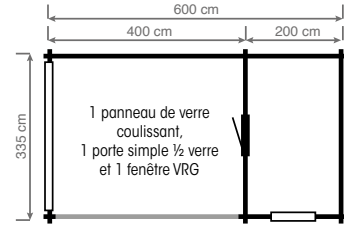

PAULI

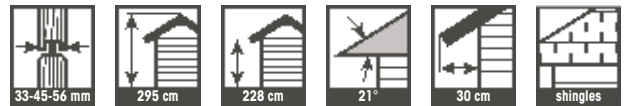
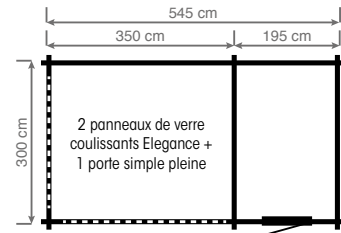

PINCHON

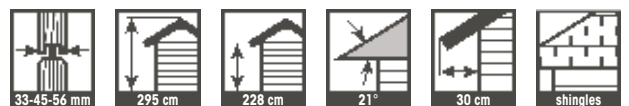
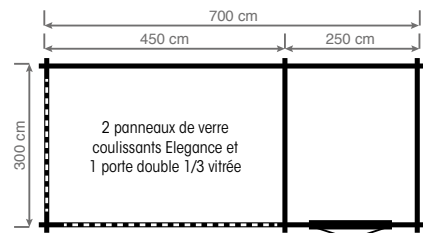

GALLE

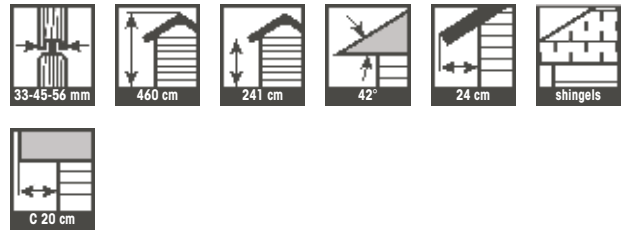
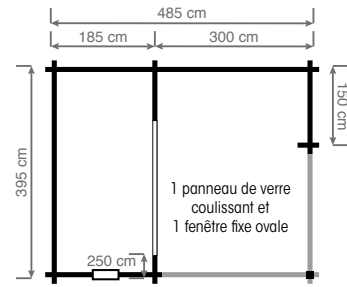

LAVOIR

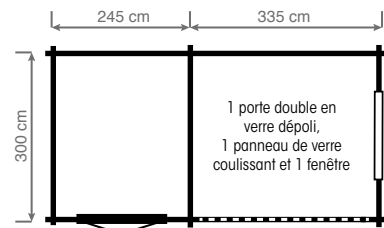

WOTUBA

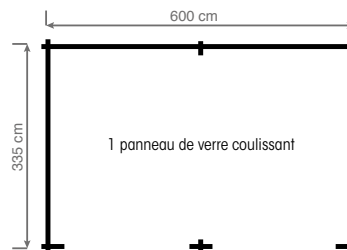

ELEGANCE

ANGELO

set de gouttières en option

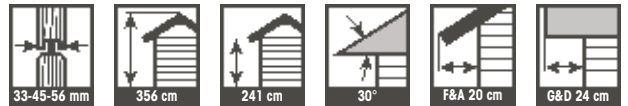
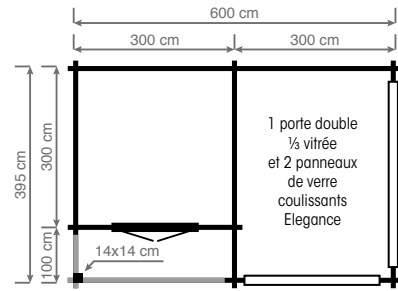

DELVAUX

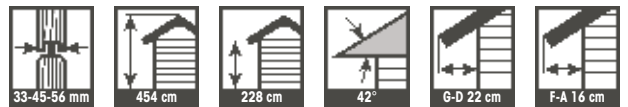
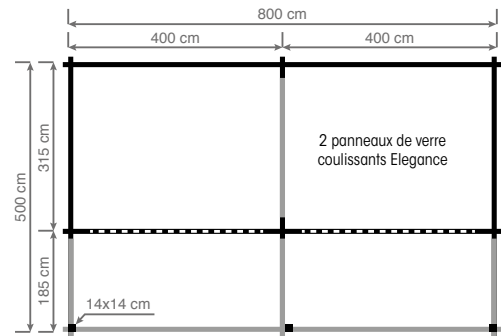



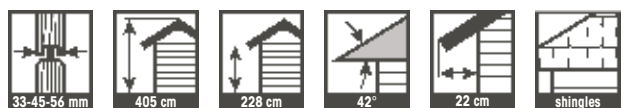
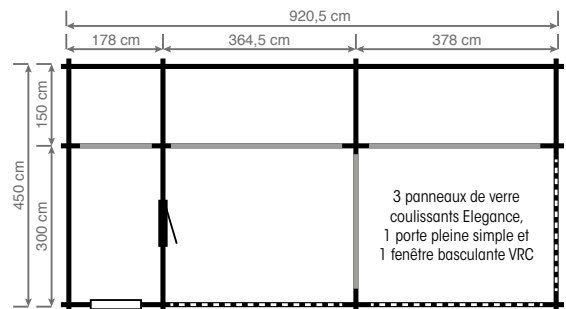

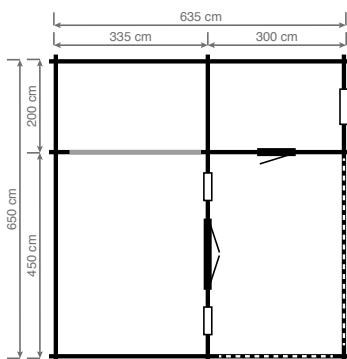

BOLDINI



MORONI



1 porte double ¾ vitrée, 1 porte simple pleine, 1 panneau de verre ES5 et ES3,
1 fenêtre basculante VRC et 5 fenêtres fixes VRL

-  45-56 mm
-  234 cm
-  450 cm
-  19-33°
-  F&A 24 cm
-  C 20 cm



PANNEAUX DE VERRE



1 Des panneaux de verre de 82 cm avec une épaisseur de 10 mm en verre de sécurité trempé et poli

2 Les panneaux de verre glissent sur 2, 3, 4 ou 5 rails

3 Un cadre en aluminium (hauteur : 2 m) en couleur anthracite (RAL 7024) ou blanc crème (RAL 9001)

4 Des poignées qui permettent de faire coulisser les panneaux automatiquement

5 Serrure à cylindre - EN OPTION: serrure à cylindre en métal anodisé avec pêne

6 Bas de porte, protection optimale contre le vent





UN TRAVAIL SUR MESURE EN 3 ÉTAPES

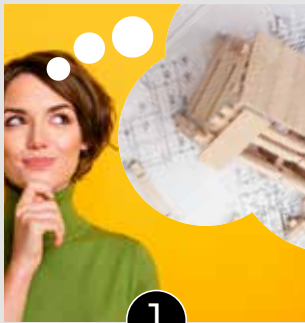

1

VOTRE IDÉE

Tout commence avec votre idée de la construction de vos rêves. Notre catalogue peut vous aider à trouver l'inspiration. Vous pouvez faire quelques dessins et/ou croquis.



2

CONTACTEZ LE POINT DE VENTE LE PLUS PROCHE

Prenez contact avec le point de vente de votre région. Vous pouvez nous rendre visite pendant les heures d'ouverture ou prendre rendez-vous avec un de nos conseillers.



3

VOTRE DEVIS PERSONNALISÉ

Notre expert traduira vos souhaits de façon technique et évaluera la faisabilité de votre projet. Sur la base de cet entretien, il vous remettra un devis personnalisé du projet de vos rêves.

**DU SUR-MESURE À
DES PRIX STANDARDS**

- ✓ UN CERTIFICAT D'AUTHENTICITÉ
- ✓ AUCUN PRODUIT VIENT D'EUROPE DE L'EST, C'EST GARANTI
- ✓ UNE GARANTIE DE 10 ANS SUR LES DÉFAUTS DE PRODUCTION ET/OU DE FABRICATION

BUREAUX DE JARDIN





BUREAUX DE JARDIN

Nos bureaux de jardin contemporains en bois vous permettront de travailler à domicile en toute quiétude en maintenant une séparation entre vos activités professionnelles et votre vie privée. Nos bureaux de jardin sont équipés de châssis de fenêtres et de portes en aluminium, elles-mêmes pourvues d'un vitrage isolant. Ils permettent ainsi de créer chez vous un lieu de travail chaleureux qui maintiendra votre productivité.

ALUMINIUM fenêtres/portes



AVANTAGES

- Plusieurs formes de toit possibles
- Épaisseur du bois 45 et 56 mm
- Fenêtres et portes en aluminium de haute qualité
- Pourvues d'un vitrage isolant
- Toiture : EPDM avec finitions en aluminium ou bardeaux disponibles en quatre couleurs

BUREAUX DE JARDIN

BEC

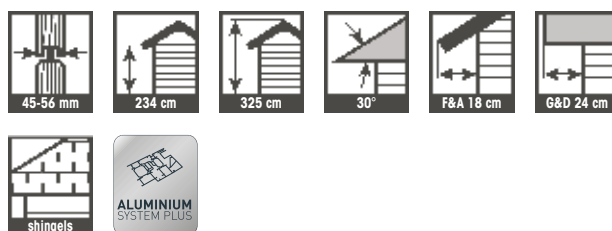
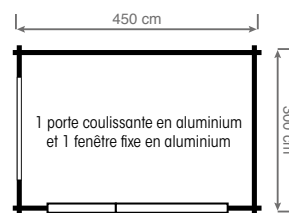

DECANIS

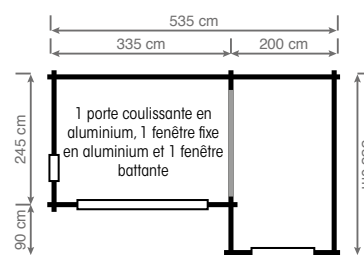

TRABENDO

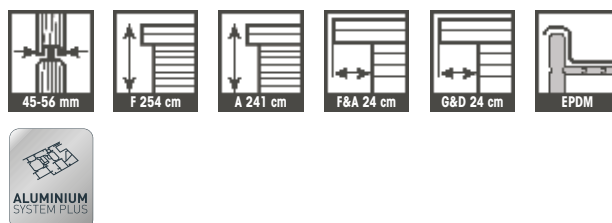
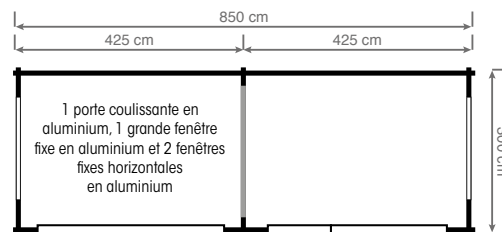

MANTECA

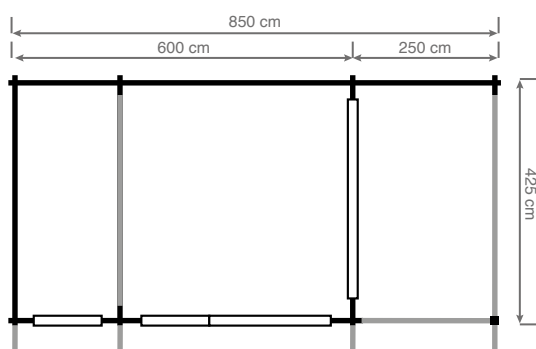

1 porte coulissante en aluminium, 1 grande fenêtre fixe en aluminium,
1 fenêtre alu fixe verticale

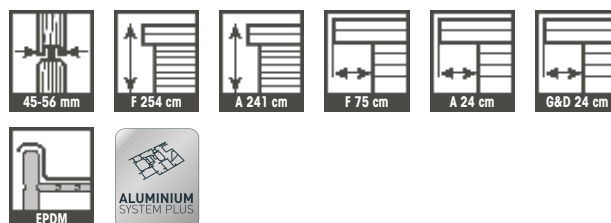

BUREAUX DE JARDIN

BLOMET

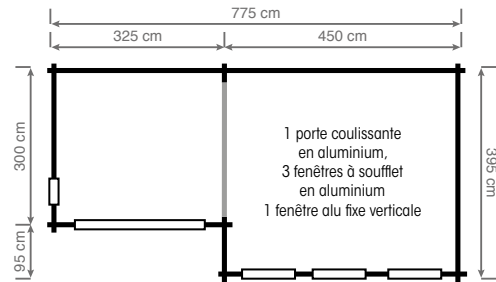

BARAKI

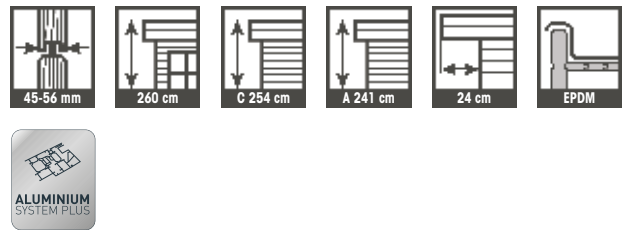
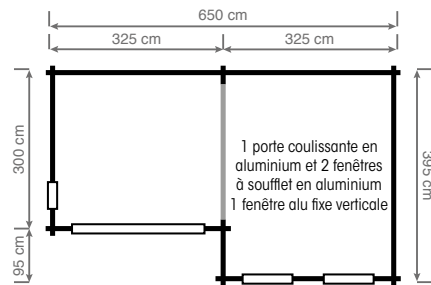

CALI

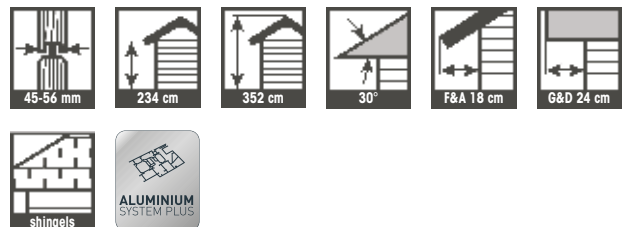
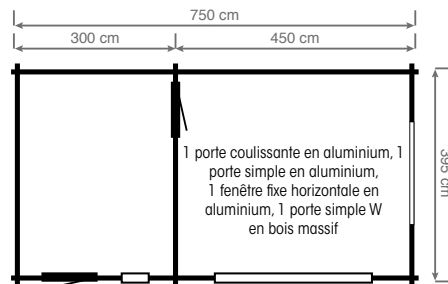

CHARONNE

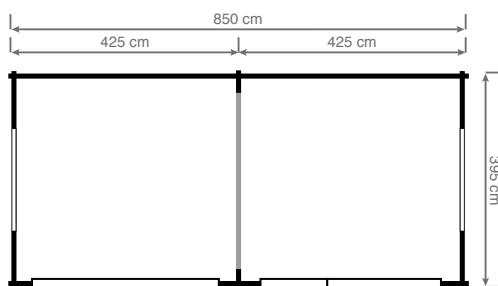

1 porte coulissante en aluminium, 1 grande fenêtre fixe en aluminium, 2 fenêtres fixes horizontales en aluminium

- 
45-56 mm
- 
234 cm
- 
352 cm
- 
30°
- 
G&D 24 cm
- 
F&A 18 cm
- 
shingels
- 
ALUMINIUM SYSTEM PLUS

INTÉRIEUR

Nos portes intérieures, parois, poutres de toit et planchers en bois massif créent un confort scandinave authentique.

Les abris de jardin en bois de Grandcasa offrent une ambiance confortable à votre intérieur.





CHALETS DE LOISIRS





CHALETS DE LOISIRS

Les abris de jardin de Grandcasa conviennent aussi très bien comme abris de vacances ou résidences d'été.

La mer, la montagne, une île exotique : nos abris de jardin s'intègrent à tous les environnements.

Bien entendu, les chalets de vacances peuvent toujours être livrés sur mesure.

Grandcasa est en effet le grand spécialiste du travail personnalisé.



AVANTAGES

Concevez vous-même votre chalet en choisissant parmi nos nombreuses options de base.

- Isolation de toiture et de plancher
- Planchers en bois, planchers de terrasses et balustrades
- Planchers de logement, élévations, parois intérieures
- Le plus grand choix de toitures
- 3 types de fenêtres et portes, double vitrage
- Gouttières : pvc ou métal galvanisé
- Escalier intérieur en bois

CHALETS DE LOISIRS

MONACO

panneaux de tuiles en option

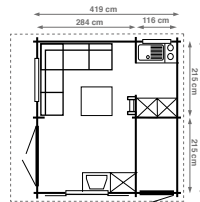

MONACO 17 m²

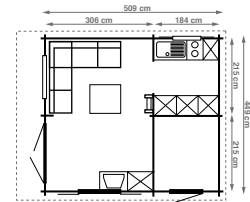

MONACO 21 m²

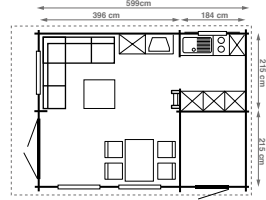

MONACO 25 m²

Portes et Fenêtres :
Ligne Confort : 1 porte double, ¼ vitrée,
1 porte pleine, 1 fenêtre VRM et 2 VRG
Monaco 25 m² : 1 fenêtre VRG en plus

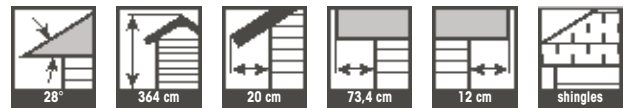
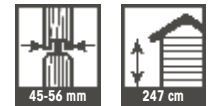

ANDORRA

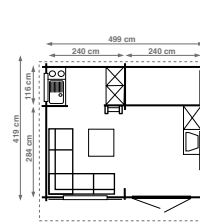

ANDORRA 20 m²

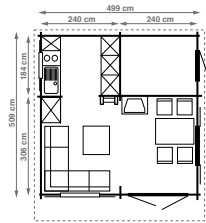

ANDORRA 24 m²

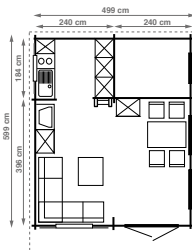

ANDORRA 28 m²

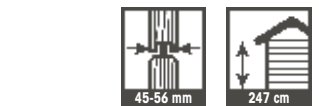

Portes et Fenêtres :
Ligne Confort : 1 porte double, ¼ vitrée,
1 porte pleine, 1 fenêtre VRM et 2 VRG
Andorra 28 m² : 1 fenêtre VRG en plus

DOMINICA

panneaux de tuiles en option

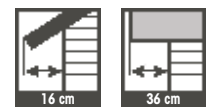
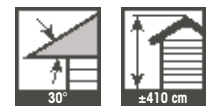
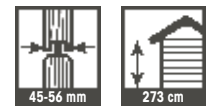
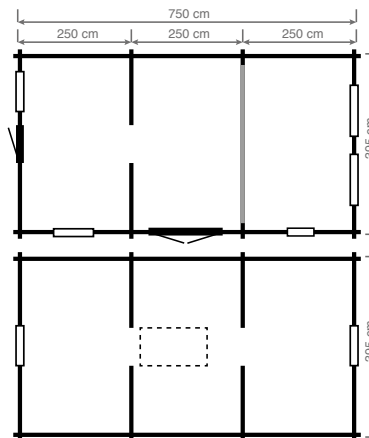

1 porte simple ½ vitrée, 1 porte double ¼ vitrée,
4 fenêtres VRC et 2 VRG + étage

MONZA

set de gouttières et panneaux de tuiles en option

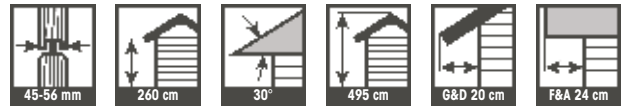
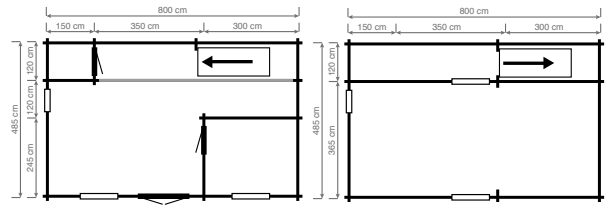

Portes et Fenêtres :
1 porte double premium, 1/2 vitrée, 2 portes intérieures
en bois massifs, 2 fenêtres oscillantes premium WRG
et 2 fenêtres premium WRM

MOUSTIQUE

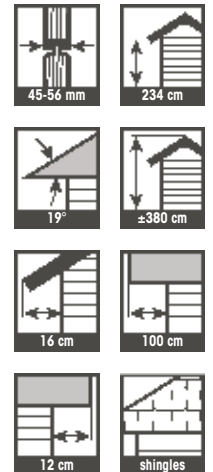
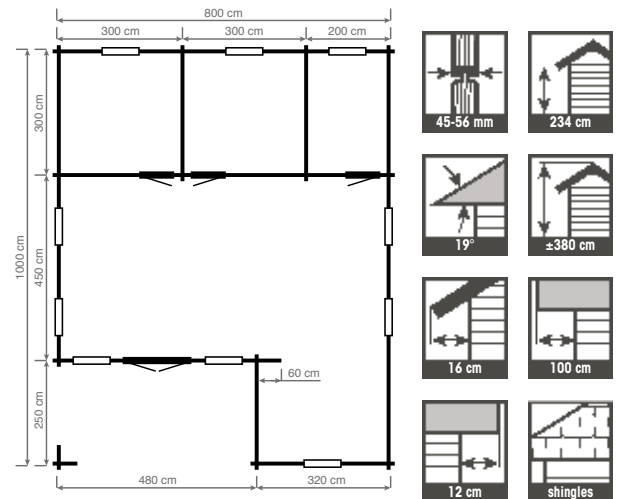

- Toit en auvent : 480 x 250 cm
- 1 porte double, 1/4 vitrée, 9 fenêtres VRG, 1 VRK et 3 portes intérieures

SABA

portes et fenêtres exclusives et set de gouttières en option

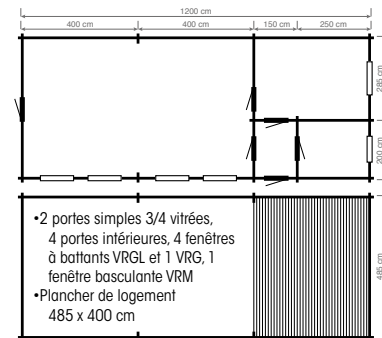

- 2 portes simples 3/4 vitrées, 4 portes intérieures, 4 fenêtres à battants VRGL et 1 VRG, 1 fenêtre basculante VRM
- Plancher de logement 485 x 400 cm

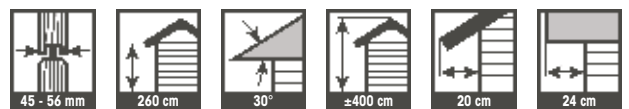

CHALETs DE LOISIRS

MADINA

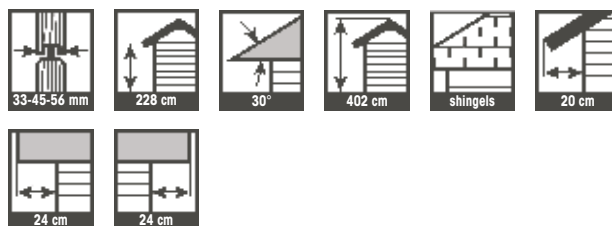
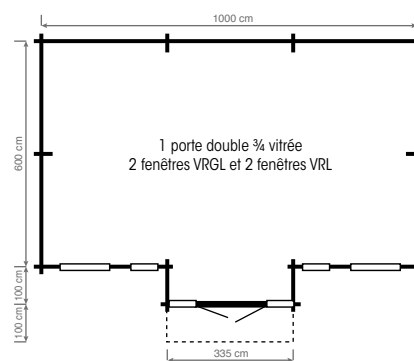

MAGRITTE

portes et fenêtres en bois dur en option

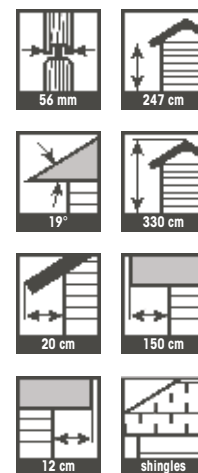
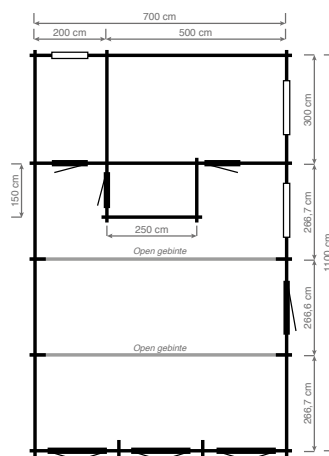

- 3 portes doubles 1/4 vitrée, 1 porte simple 1/2 vitrée, 3 portes intérieures, 4 fenêtres VRG à deux ouvrants et 1 fenêtre VRC basculante

GRACIOZA

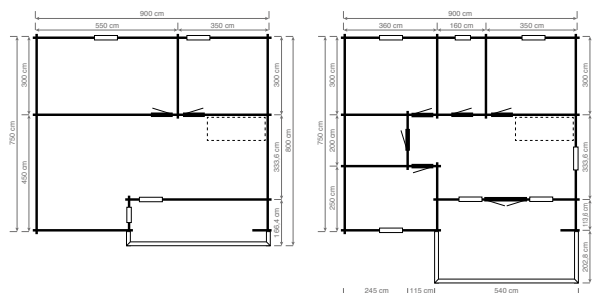

- Vide : ± 12 m², terrasse ± 16 m² avec plancher, balcon ± 8.5 m²
- Toit en auvent : 550 x 100 cm avec plancher de terrasse
- Division intérieure selon plan
- 1 porte double 1/4 vitrée, 1 porte simple VDE34, 5 fenêtres VRG, 2 VRM, 2 VRC, 2 VRLX, 1 VRGL et 7 portes intérieures

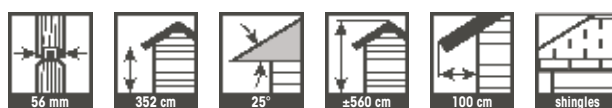

PICON panneaux tuiles en option

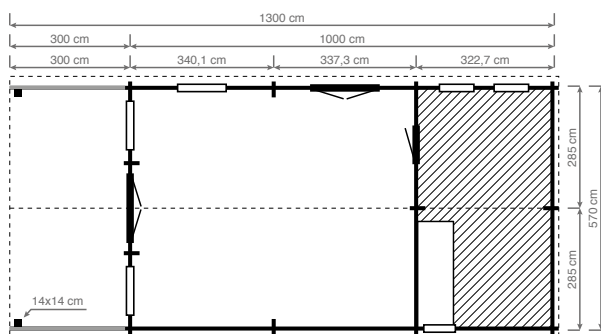

- 2 portes en verre premium, 1 porte intérieure en bois massif,
- 2 fenêtres premium WRM, 3 fenêtres premium WRGL et 2 fenêtres tabatières

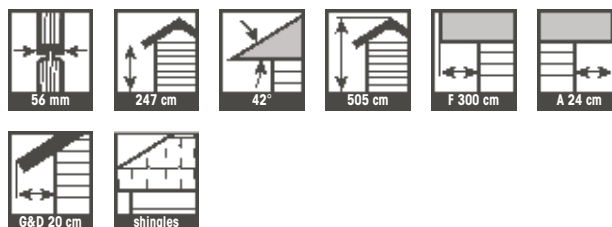

CHALETS DE LOISIRS

SIKLOS

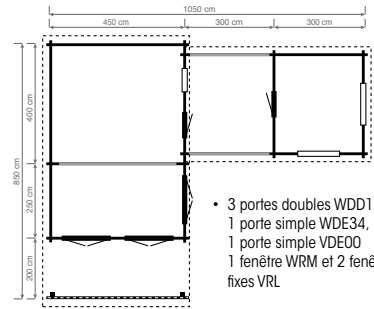

- 3 portes doubles WDD11,
- 1 porte simple WDE34,
- 1 porte simple VDE00
- 1 fenêtre WRM et 2 fenêtres fixes VRL

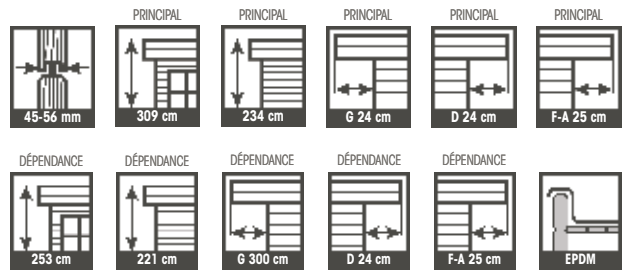

MIMAS TANGUY

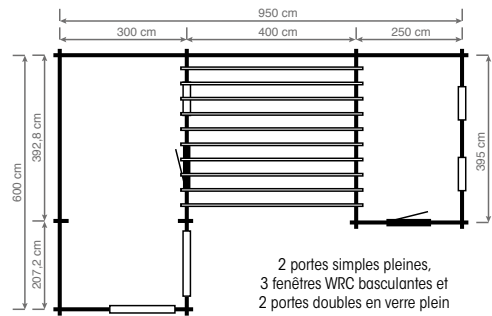

- 2 portes simples pleines,
- 3 fenêtres WRC basculantes et
- 2 portes doubles en verre plein



UFURI

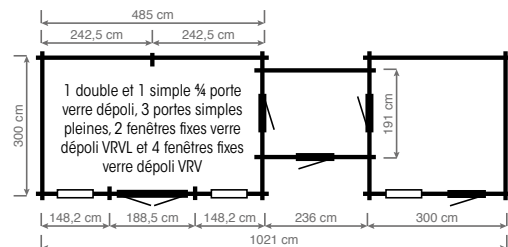

- 1 double et 1 simple ¼ porte
- verre dépoli, 3 portes simples
- pleines, 2 fenêtres fixes verre
- dépoli VRVL et 4 fenêtres fixes
- verre dépoli VRV

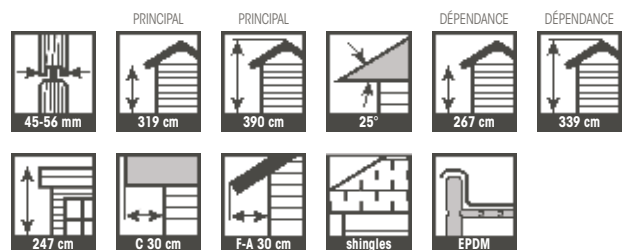

ALEGRANZA toit en chaume en option

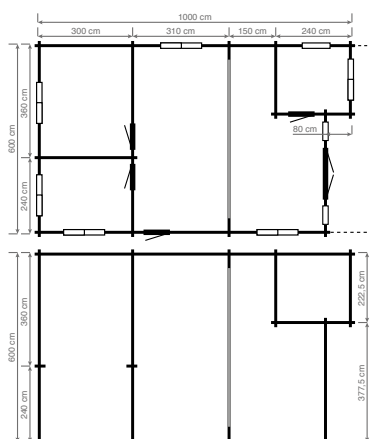

- 1 porte double ¾ vitrée, 3 portes intérieures, 6 fenêtres VRG à deux ouvrants, 3 fenêtres VRK basculantes et 1 fenêtre VRC basculante
- Plancher de logement 600 x 300 cm

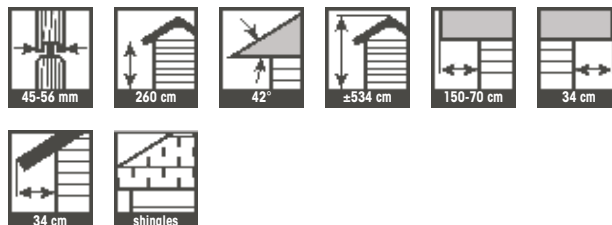

CHALET DE LOISIRS

KILAKU

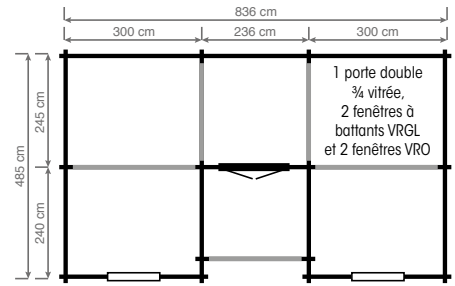

1 porte double
¾ vitrée,
2 fenêtres à
battants VRGL
et 2 fenêtres VRO

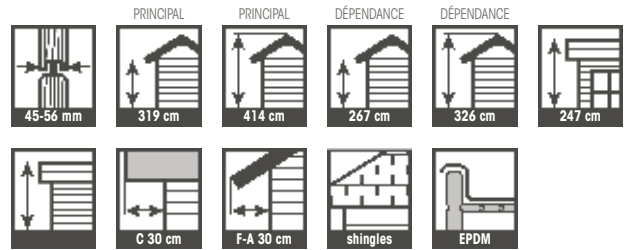

ZAMBEZI

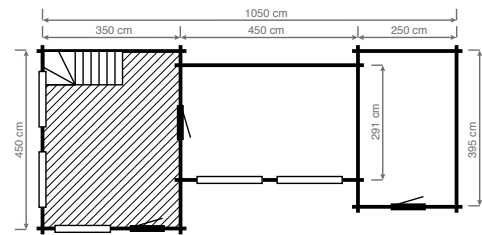

2 portes en verre plein doubles, 3 portes pleines et 3 fenêtres fix VRL

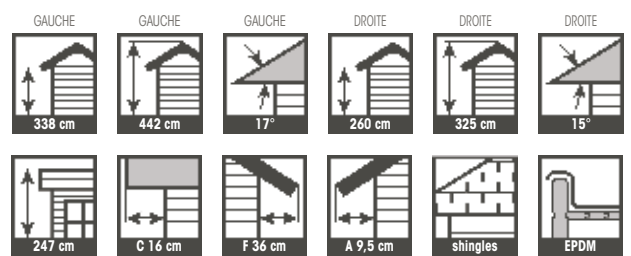

KURAMATHI

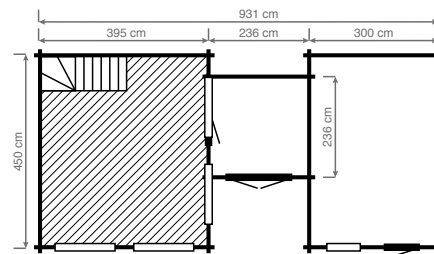

1 porte double ½ vitrée, 2 portes simples pleines,
4 fenêtres fixes VRL et 1 fenêtre basculante VRM

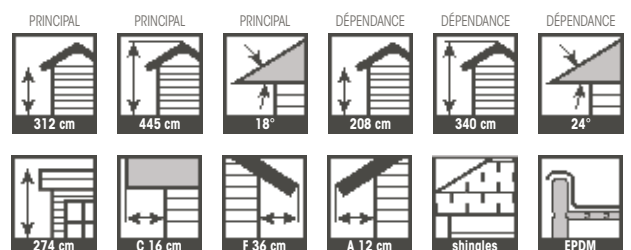

SONIRO

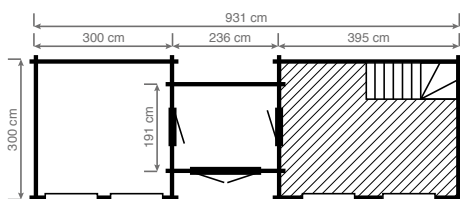

1 porte double ¾ vitrée, 2 portes simples pleines.
4 fenêtres à battants VRGL et 2 fenêtres fixes VRL

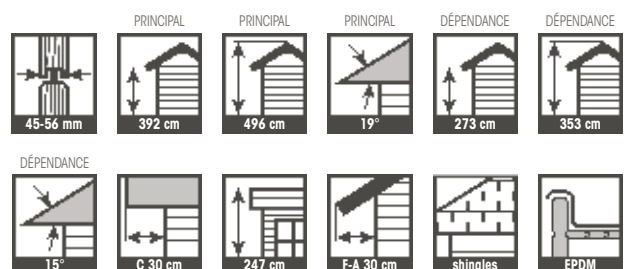



ISOLATION DU TOIT

Isolation du toit 60 mm (au-dessus)

- Lattage toiture
- Barrière de vapeur (fermée)
- Isolation 60 mm
+ poutres 60 mm
- Panneaux OSB 15 mm
- Pare-vapeur (ouvert)
- Couverture du toit

Isolation du toit 150 mm (sous le toit)

- Lattage du toiture 19 mm (plafond)
- Barrière de vapeur (fermée)
- Isolation 150 mm
+ solives de toit
- Pare-vapeur (ouvert)
- Couverture du toit



ISOLATION DE PLANCHER

- Barrière de vapeur (ouvert)
- Poutres de plancher 58 x 58 mm
- Isolation 60 mm
- Barrière de vapeur (fermée)
- Plancher 19 mm

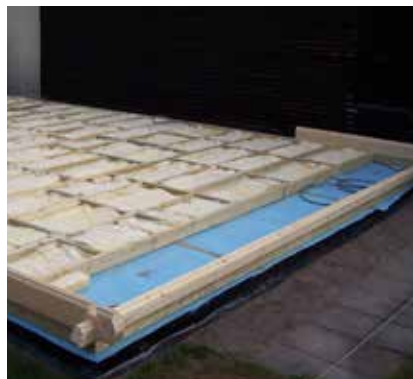



PEFCTM

PEFC/07-31-200

POUR LA GESTION DURABLE DES FORÊTS

GARAGES



La gamme de garages de Grandcasa est assez unique, même en Europe. Basé sur notre profil d'abri de jardin, nous avons développé un concept permettant d'enjamber de grands espaces, comme des garages, qui sont disponibles en plusieurs épaisseurs.



PORTE EN BOIS ROTATIVE (= STANDARD)

- Constituée de 2 battants
- Dimensions : 250 x 216 cm (E x H)
- Charnières lourdes et réglables galvanisées
- Latte de sol galvanisée en métal
- Habillée avec des planches de 16 mm
- Ferrures de porte en acier inoxydable



PORTE BASCULANTE

- Porte basculante blanche ou noire
- Dimensions : 237 x 200 cm
- Prévues d'une serrure à cylindre et une poignée synthétique
- Amortisseur pour une isolation acoustique optimale
- Disponibles en autres dimensions et couleurs RAL



PORTE SECTIONNELLE

- S'ouvre verticalement et permet une meilleure utilisation d'espace
- Dimensions = environ le passage entier
- isolation EPU à double paroi
- Finition Woodgrain
- Couleur blanche standard, autres couleurs RAL disponibles
- Plusieurs dimensions disponibles
- Automatisation et commande à distance disponibles

Nos garages sont disponibles en 3 exécutions : Classic, Colorado et Cosmos. Chacune d'entre elles peut bien entendu être réalisées en de nombreuses dimensions. Nous avons acquis une position unique sur le marché des garages doubles.

AVANTAGES

- Chaque construction présente au moins 1 chevron intermédiaire avec poutres de renforcement. Au moins 2 chevrons et renforcements, en fonction de la profondeur
- Epaisseurs de bois possibles : 33, 45 ou 56 mm
- 3 types de portes : Porte basculante en métal, porte sectionnelle ou porte en bois rotative (= standard)
- Fenêtres/portes et cloisons intérieures à ajouter selon vos désirs

GARAGES



Façade:	1 - 10 m
Profondeur:	1 - 30 m
Hauteur de faîte:	Classic de 2,76 jusqu'au 3,28 m
Pignons ouverts intermédiaires:	< 7m : 1 pignon ; > 7 m : 2 pignons
Fenêtres et portes:	Tous les fenêtres et portes sont possibles !



OPTION: portes sectionnelles en couleurs RAL





CLASSIC GARAGES



COSMOS GARAGES



OPTION: portes sectionnelles sur mesure



Configurations possibles



GARAGES

BUDA

set de gouttières en option

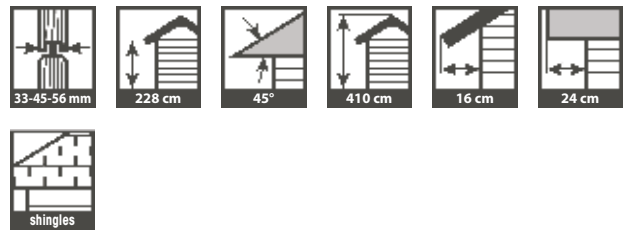
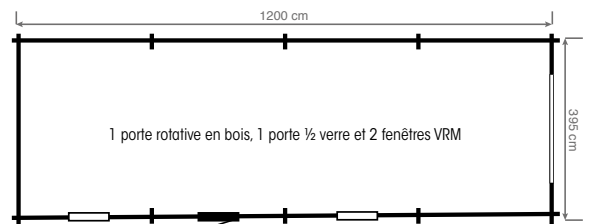

FLORENCE

set de gouttières en option

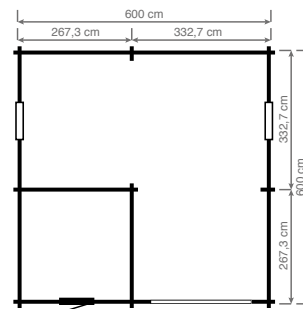

Equippé d'une porte en bois à double battants, 2 fenêtres VRG et 1 porte simple, 1/2 vitrée.

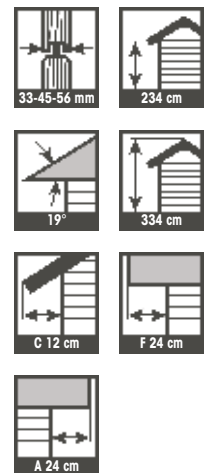

TOBAGO

portes basculantes en option

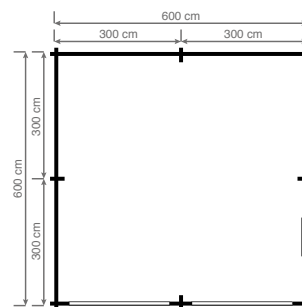

Equippé de deux portes basculantes, une porte simple 1/2 vitrée et une fenêtre à battants VRG

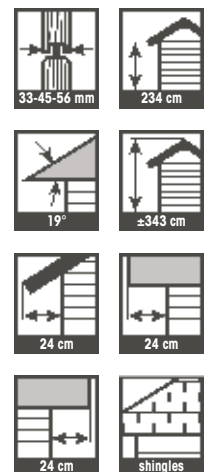

ZAPATO

set de gouttières en option

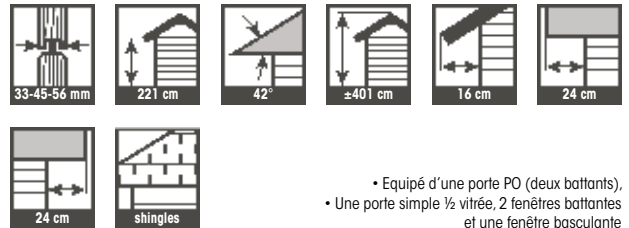
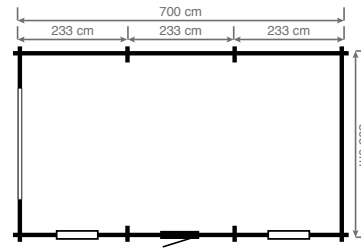

CORNWALLIS

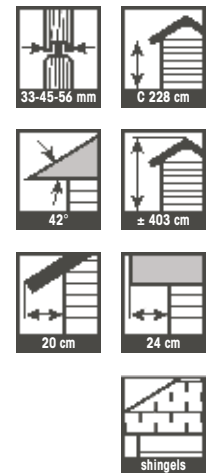
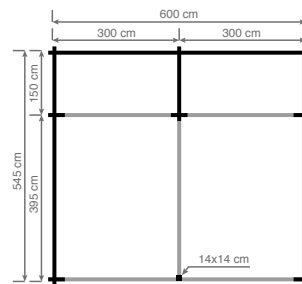

GRANADA

portes basculantes en option

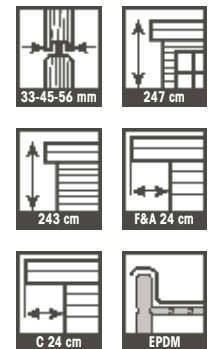
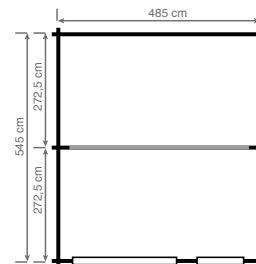

Equipé d'une porte (deux battants) et une fenêtre battante

GARAGES

PULSIANO

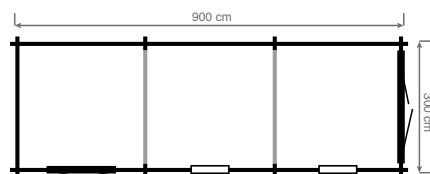

1 porte rotative, 1 porte double ½ verre
et 2 fenêtres basculantes VRI



MONTEGO

porte basculante et set de gouttières en option

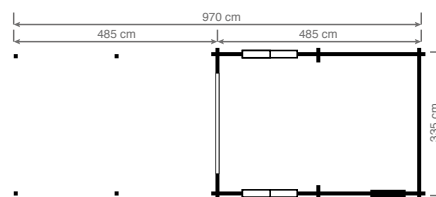

• Equipé d'une porte en bois à double battants, 1 porte simple,
½ vitrée et 2 fenêtres VRG fixées
• Poteaux de soutien: 14 x 14 cm

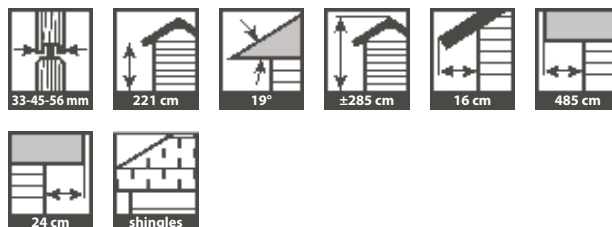

GERONA

panneaux de tuiles et volets en option

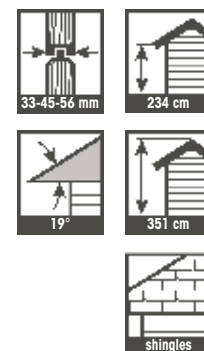
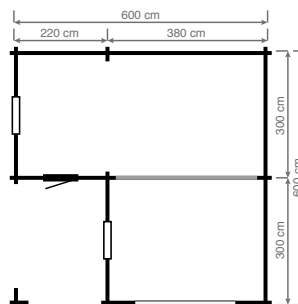







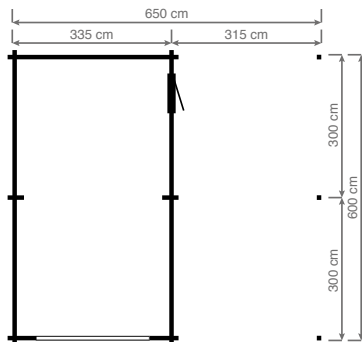

• Equipé d'une porte en bois à double battants, 2 fenêtres VRG et 1 porte simple, ½ vitrée
• Toit en auvent 220 x 300 cm avec plancher de terrasse

BECEDAS

porte sectionnelle en option



- Equipé d'une porte BPO (deux battants) et une porte simple pleine
- Auvent 600 x 338 cm

 45-56 mm	 234 cm	 19°	 ±339 cm	 16 cm	 24 cm
 24 cm	 shingles				

GARAGES

LOKONO

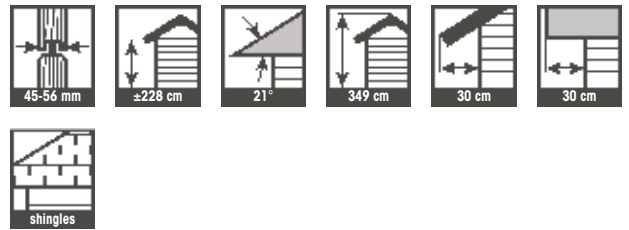
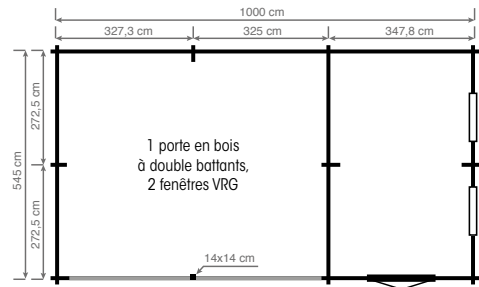

MABELIE

fenêtres et portes en option

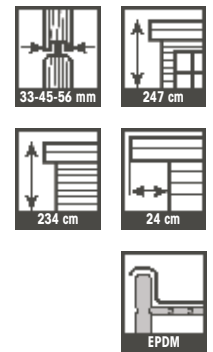
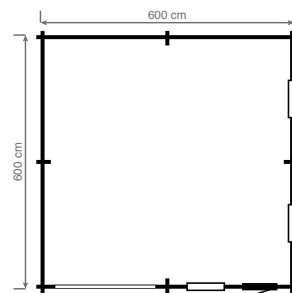

- 1 porte basculante métallique, 1 porte simple
1/2 vitrée, 1 fenêtre basculante VRM et 2
fenêtres à battants VRG

ORKNEY

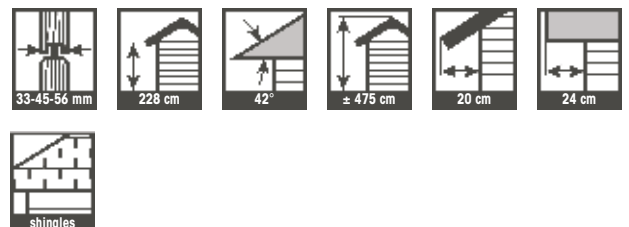
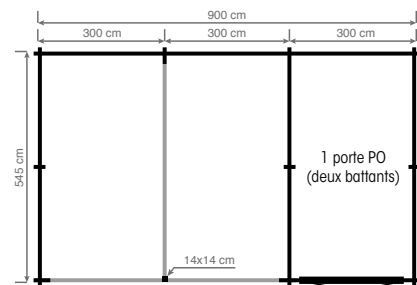

LESTER

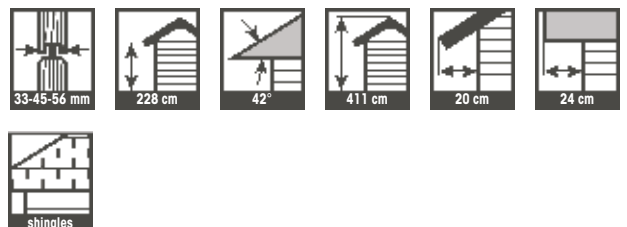
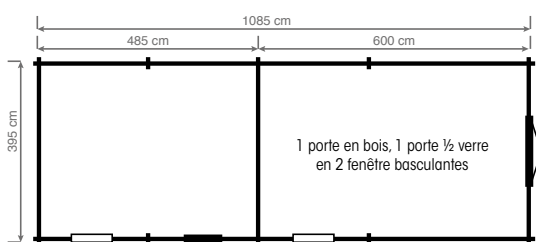

TONNELLES





TONNELLES

Des patios exceptionnels, spécialement conçus pour vous faire profiter pleinement de votre jardin.

Ces pavillons de luxe sont aussi des abris idéals pour un bain bulles ou un ensemble de meubles de jardin distingué.

AVANTAGES

- Un toit plat, un toit royal ou un toit cottage
- La hauteur de base des côtés est de 228 cm et l'épaisseur des murs est de 45 mm
- De robustes poteaux de soutien de 14x14 cm
- Toiture : EPDM avec finitions en aluminium ou shingles (4 couleurs)
- En option : terrasse avec revêtement anti-dérapant 28 x 145 mm
- Balustrades CROSS ou BARS (structures de 38 x 89 mm et poutres de 45 x 145 mm)

OPTION: balustrades



TONNELLES

ARUBA

set de gouttières et panneaux de jardin en option

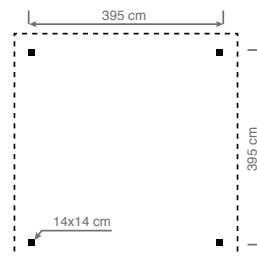

- Toit pyramidal avec sous-toiture en bois massif de 19 mm
- Poteaux de soutien robustes de 14 x 14 cm avec étaçons et solive



CUPID

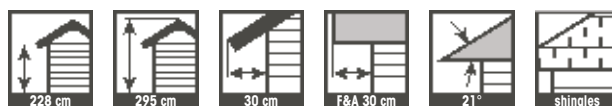
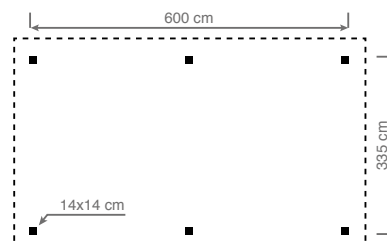

VENUS

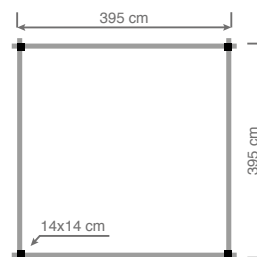

THOR

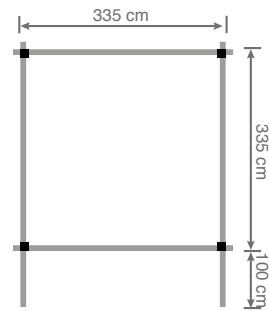

45 mm 221 cm 275 cm 19° 16 cm shingels

EROS

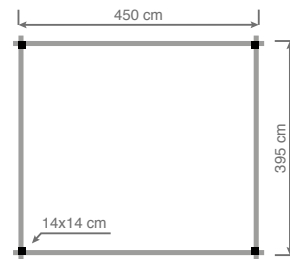

45 mm 221 cm 293 cm 19° 24 cm shingels

HEFI

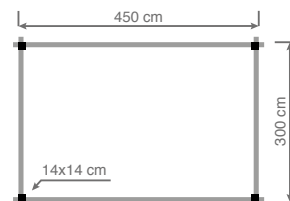

45 mm 221 cm 277 cm 42° 24 cm shingels

TONNELLES

DANZA

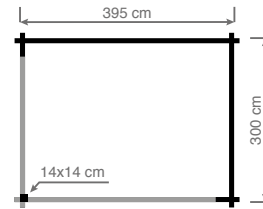

- Parois ouvertes, demi-ouvertes ou pleines : faites votre choix !
- Poteaux de soutien robustes de 14 x 14 cm

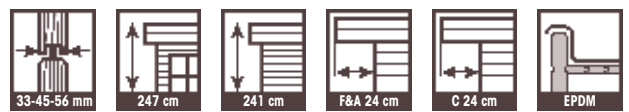

MARIPOSA

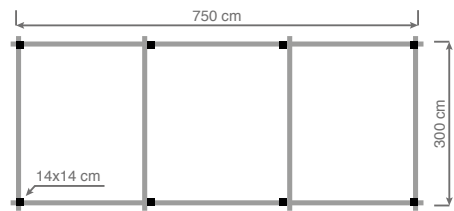

APHRODITE

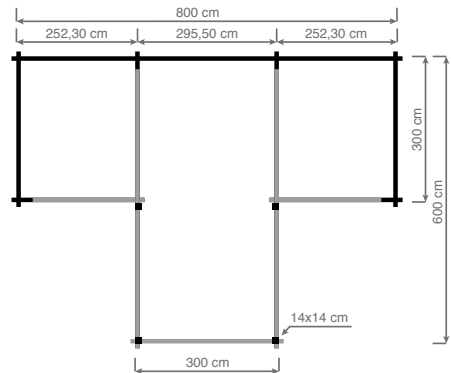

AMOR

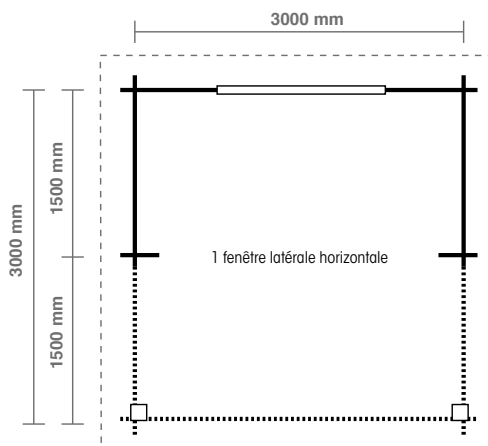

- 33-45-56 mm
- 228 cm
- 286 cm
- 21°
- 30 cm
- shingles

TONNELLES

HATHOR

Set de gouttières et panneaux en option

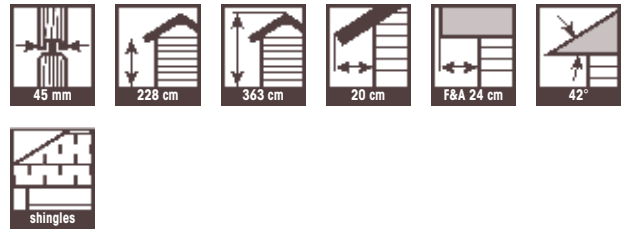
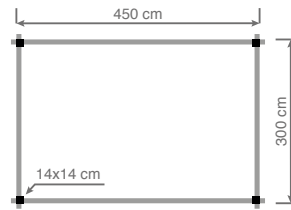

ROMEO

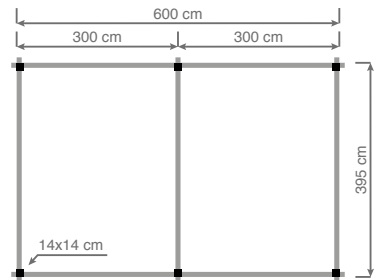

CLEOPATRA

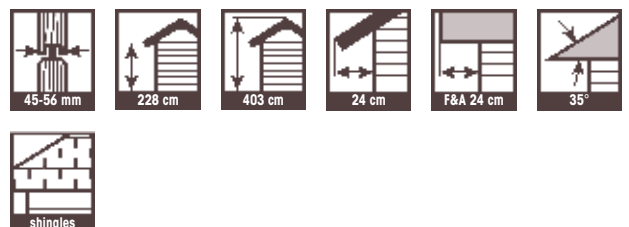
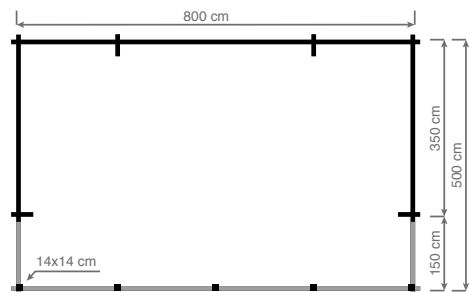

CARPORT EN ANNEXE SUR MESURE



- Poteaux de support 14 x 14 cm avec étais (3)
- Toiture en EPDM avec finition en alu
- Gouttières de toit, diamètre 8 cm, système de vidange inclus (1)
- Poutres de toit 58 x 165 mm (2)
- Lattage du toit en bois massif 19 mm (2)
- Fixation à l'aide des supports muraux
- En option : poutres de support 360 cm. Idéal pour des mobil homes ou des camionnettes (4)



OPTIONS ET AVANTAGES



ABRI DE JARDIN ANNEXE

- Hauteur côté extérieur 163 cm, côté annexe 195 cm
- Pente 12°, shingles inclus
- Débord du toit : façade 11 cm, arrière 11 cm, côté 20 cm



PENTE

- Adaptable, 42° maximum
- Pente minimale selon la toiture et le type d'abri de jardin



SOCLE

- Poteaux 14 x 14 cm
- Hauteur 60 cm avec bois de finition
- Planches de 25 mm épaisseur
- Sapin blanc ou chêne



MEZZANINE

- Grenier à dormir confortable
- Avec balustrade
- Le tout selon la construction de base



AUVENT

- Large débord de toit, standard 100 cm
- Plusieurs dimensions possible



APPENTIS INTÉGRÉ

- Joli appentis
- Disponible dans toutes les dimensions possibles
- Avec ou sans plancher de terrasse



BALUSTRADE & TERRASSE

- En poutres traitées autoclaves de 58 x 58 mm
- Planches de terrasse antidérapantes et traitées autoclaves
- Finition avec une balustrade en bois. Epaisseur du bois identique à celle du bois des abris de jardin



ÉTAGE

- Poutres d'étage très résistantes de 58 x 165 mm
- Planches de toit massives de 19 mm



PORTES INTÉRIEURES

- Portes intérieures massives en sapin de Norvège
- Finition élégante

CHEVRONS OUVERTS

- Charpente ouverte très esthétique
- Construction avec poutres de toit de 58 x 165 mm
- Applicable à des constructions de 45 et 56 mm



PORTE D'ANGLE

- Porte disposée en biais, dans l'angle
- Porte simple ou double
- Option avec plancher présassemblé de longueur maximale 386 mm
- Idéal pour une construction d'angle, dans le jardin



REHAUSSEMENTS

- Possibilité de rehaussement par tranches de 13 cm
- Pour toutes les épaisseurs de bois
- Applicable à tous nos abris de jardin



PLANCHER EN BOIS

- Poutres traitées autoclaves de 58 x 58 mm
- Distance entre les poutres de plancher : 40 cm
- Charge illimitée
- Planches de sol massives de 19 mm, avec dent et rainure



TRAITEMENT AUTOCLAVE

- Imprégnation sous vide et sous haute pression
- Protection contre les moisissures et insectes
- Sans parfum ni odeur
- Possibilité de peinture ou teinture après séchage



JEU DE GOUTTIÈRES EN PVC OU GALVANISÉES

- Jeu de gouttières en PVC
- PVC gris de qualité supérieure
 - 80 mm de diamètre
 - Avec tuyaux d'évacuation jusqu'au niveau du terrain

- Jeu de gouttières GALVANISÉES
- Métal galvanisé
 - 125 mm de diamètre pour un grand débit
 - Avec tuyaux d'évacuation jusqu'au niveau du terrain



CHARPENTE

- Poutres de toit robustes de 58 x 165 mm (soudées)
- Classe de résistance C 24
- Planches massives et décoratives de 19 mm (avec dent et rainure)



PIED ADAPTABLE

- Support de poteau réglable,
- Plaque supérieure 80/80,
- Plaque inférieure 160/80, 6 mm d'épaisseur
- Pied en acier galvanisé blanc



ESCALIERS

1. Escalier Confort
 - Hauteur max. 280 cm, 13 marches
 - Marches: 14 cm de profondeur
 - Largeur: 65 cm
2. Escalier Premium
 - Hauteur max. 280 cm, 13 marches
 - Droit ou quart tournant
 - Largeur: 80 cm
 - Marches: 19 cm de profondeur

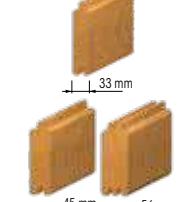

PAROIS

- Parois avec dent et rainure de 15 mm
- Epaisseurs du bois : 33, 45 et 56 mm
- Raccords d'angle droits ou joliment arrondis

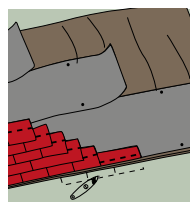

SOUS-TOITURE

- Film synthétique pare-vapeur et très résistant à l'eau
- Epaisseur : 520 microns
- Résistant aux UV
- A appliquer



SOUDÉ

- Montant de porte soudé et laminé
- Résiste au gel et à l'humidité
- Le travail naturel du bois est neutralisé



TOIT EN CROUPE

- Triangle pré-monté en planches de 19 mm
- Poutres de support 38 x 89 mm
- Possible sur les toits 2 batières en pente 42°

GRILLE D'AÉRATION

- Double grille, dimensions : 200 x 60 mm, aluminium gris argenté, toile moustiquaire collée dans la grille
- Garantit une aération optimale et une grande longévité



BOIS DE CONSTRUCTION

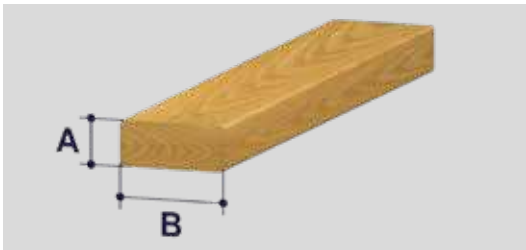

BOIS NON-TRAITÉ RABOTÉ 4 FACES

Dimensions A x B (mm)	Type	Longueurs disponibles (mm)
11 x 35	Bois de construction	2100
12 x 45	Bois de construction	2100
120 x 120	Duo / Collé	2400 - 3600
140 x 140	Duo / Collé	2400 - 3600
16 x 32	Bois de construction	3600
19 x 68	Bois de construction	3900
22 x 35	Bois de construction	2100
33 x 145	Bois de construction	4500 - 5400
38 x 89	Bois de construction	3600 - 5400
45 x 145	Bois de construction	3600 - 4500 - 5400 - 6000
45 x 195	Bois de construction	3600 - 5400
58 x 165	Bois de construction entures multiples	6000 - 7000 - 8000 - 9000



BOIS À RAINURE - NON TRAITÉ

Dimensions A x B (mm)	Type	Longueurs disponibles (mm)
16 x 32	Latte de finition sol	3600
19 x 145	Planche de rives	2380 - 2830 - 3390 - 4800
19 x 69	Finition planche de rives	2380 - 2830 - 3390
16 x 69	Latte de finition toit	3600
33 x 84	Planche de finition	3600 - 5400
38 x 58	Débord du toit sauna	3900



BOIS À RAINURE ET LANGUETTE - NON TRAITÉ

Dimensions A x B (mm)	Type	Longueurs disponibles (mm)
16 x 122 (115)	Toit/plancher	1754 - 1828 - 2310 - 2480 - 2706 - 3011 - 3368
19 x 122 (115)	Toit/plancher	1420 - 1500 - 1720 - 1920 - 2220 - 2310 - 2760 - 2905 - 3020 - 3255 - 3320 - 3860
28 x 145 (132)	Plafond sauna	3900
28 x 145 (130)	Parois	900 - 1200 - 1500 - 1800 - 2100 - 2400 - 2700 - 3300 - 4200 - 4800
33 x 145 (130)	Parois	1350 - 1800 - 2250 - 2700 - 3300 - 3600 - 4200 - 5100 - 5700
45 x 145 (130)	Parois	900 - 1350 - 1800 - 2250 - 2700 - 3300 - 3600 - 4200 - 5100 - 5700 - 6000
56 x 145 (130)	Parois	900 - 1350 - 1800 - 2250 - 2700 - 3300 - 3600 - 4200 - 5100 - 5700 - 6000
28 x 97,5	Bois lanquette	3600 - 5000
28 x 97,5	Rainure / lanquette	3600 - 5000
28 x 97,5	Bois / rainure	3600 - 5000



BOIS TRAITÉ AUTOCLAVE

Dimensions A x B (mm)	Type	Longueurs disponibles (mm)
38 x 58	Bois de construction	3600
38 x 89	Bois de construction	4200
58 x 58	Poutre pour plancher	2450 - 3000 - 3350 - 3950 - 4850
28 x 145	Planche de terrasse	3300 - 4200
45 x 90	Poutre de fondation profilé	4200





UN TRAVAIL SUR MESURE EN 3 ÉTAPES

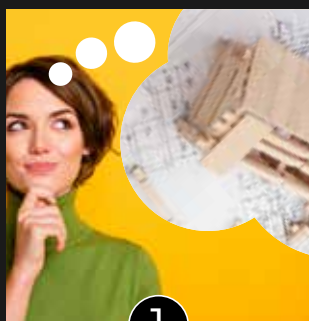

1

VOTRE IDÉE



2

CONTACTEZ LE POINT DE VENTE LE PLUS PROCHE

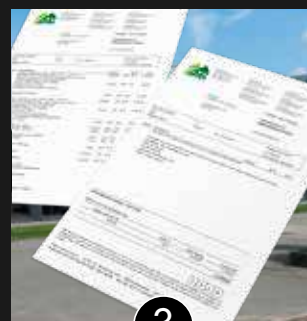

3

VOTRE DEVIS PERSONNALISÉ

 www.chaletcenter.com
 www.chaletcenter.fr

Il est strictement interdit de reprendre, en tout ou en partie, des modèles de maisons de jardin / abris de jardins, systèmes modulaires, plans de construction, photos et/ou passages de texte, de les photocopier ou de les utiliser de quelque manière que ce soit, sans l'autorisation formelle de Top-Cottage. Les formats et dimensions mentionnés dans cette brochure ne sont pas contraignants et s'entendent sous réserve de modifications des modèles, fautes d'orthographe et erreurs d'impression.